

# Components - Structure Under the Work Surface

## Recessed Base

### RA55

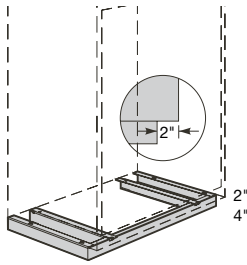

Designed to raise the height of a cabinet by 2" or 4";  
Compatible with RA56 straight cover plate for back; Includes a removable cover plate at the front for aesthetics and in order to move the cabinet from the front; Front cover plate is on a straight angle to facilitate cleaning floors;  
Leaves a 2" space to allow user to stand closer to cabinet;  
Designed to allow user to anchor the cabinet to the floor;  
Compatible with leveling glides (RA74);  
Note: Not compatible with casters;  
Note: Not designed for stacking applications.

| Product #   | W x D     | Height |
|-------------|-----------|--------|
| RA55-242102 | 24" x 21" | 2"     |
| RA55-242702 | 24" x 27" | 2"     |
| RA55-302102 | 30" x 21" | 2"     |
| RA55-302702 | 30" x 27" | 2"     |
| RA55-242104 | 24" x 21" | 4"     |
| RA55-242704 | 24" x 27" | 4"     |
| RA55-302104 | 30" x 21" | 4"     |
| RA55-302704 | 30" x 27" | 4"     |

## Straight Cover Plate

### RA56

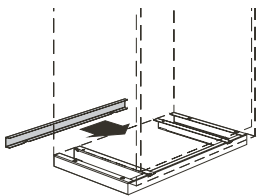

Closes off the back of 2" and 4" recessed bases.

| Product # | W x H    |
|-----------|----------|
| RA56-2402 | 24" x 2" |
| RA56-2404 | 24" x 4" |
| RA56-3002 | 30" x 2" |
| RA56-3004 | 30" x 4" |

## 4" Casters

### RB81



Sold in pairs;  
Choice of 3 types of casters: rigid, swivel, swivel with total-lock brake system (on wheel and swivel);  
Capacity : 420 lb per caster;  
Total height : 5 1/4";  
Dark gray polyurethane tread, does not mark floors. Superior industrial quality casters;  
Install directly under cabinet without base.

| Product # | Type of Caster                      |
|-----------|-------------------------------------|
| RB81-01   | Rigid                               |
| RB81-02   | Swivel                              |
| RB81-03   | Swivel with total-lock brake system |

## 6" Mag Casters

### RB85



Sold in pairs;  
Choice of 3 types of casters: rigid, swivel, swivel with total-lock brake system (on wheel and swivel);  
Aluminium wheel with durable chrome plating;  
Capacity: 1000 lb per caster;  
Total height: 7 1/2";  
Black high grade polyurethane tread, facilitates movement. Superior industrial quality casters;  
Install directly under cabinet without base.

| Product # | Type of Caster                      |
|-----------|-------------------------------------|
| RB85-01   | Rigid                               |
| RB85-02   | Swivel                              |
| RB85-03   | Swivel with total-lock brake system |

## Forklift Base

### RA52 / RA53

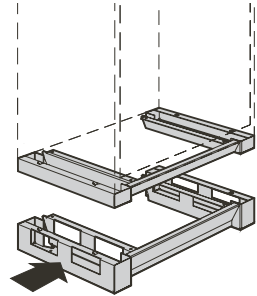

2" high base designed for moving the cabinet from the front with a forklift;  
4" high base designed for moving the cabinet from the front or side with a forklift, or from the front with a pallet-jack;  
Compatible with the RA54 rear base cover plate, offered as an option;  
Includes a recessed kick-plate in the center of the cabinet to allow user to stand closer to cabinet;  
Designed to enable user to anchor cabinet to the floor;  
Compatible with leveling glides (RA74);  
Note: Not compatible with casters.

| Product #   | W x D     | Height |
|-------------|-----------|--------|
| RA52-242102 | 24" x 21" | 2"     |
| RA52-242702 | 24" x 27" | 2"     |
| RA52-302102 | 30" x 21" | 2"     |
| RA52-302702 | 30" x 27" | 2"     |
| RA53-242104 | 24" x 21" | 4"     |
| RA53-242704 | 24" x 27" | 4"     |
| RA53-302104 | 30" x 21" | 4"     |
| RA53-302704 | 30" x 27" | 4"     |

## Angled Cover Plate

### RA54

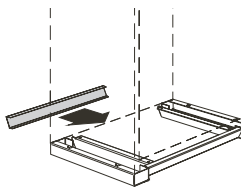

Closes off the back of 2" and 4" forklift bases.

| Product # | W x H    |
|-----------|----------|
| RA54-2402 | 24" x 2" |
| RA54-2404 | 24" x 4" |
| RA54-3002 | 30" x 2" |
| RA54-3004 | 30" x 4" |

## 6" Casters

### RB84



Sold in pairs;  
Choice of 3 types of casters: rigid, swivel, swivel with total-lock brake system (on wheel and swivel);  
Capacity : 900 lb per caster;  
Total height : 7 1/2";  
Dark gray polyurethane tread, insures silent functioning. Superior industrial quality casters;  
Install directly under cabinet without base.

| Product # | Type of Caster                      |
|-----------|-------------------------------------|
| RB84-01   | Rigid                               |
| RB84-02   | Swivel                              |
| RB84-03   | Swivel with total-lock brake system |

## Leveling Glide Kit

### RA74

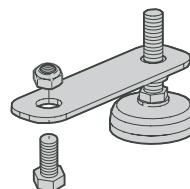

Sold in kits of 4;  
Serves to adjust the height of cabinet of 1 1/8" to 2" housings on uneven floor surfaces.

| Product # |
|-----------|
| RA74-01   |

# Components – Structure Under the Work Surface

## Drawers, Roll-out Shelves and Locking or Security Mechanisms

WORK CENTER

### Modular Drawers for Cabinet

RF31



400 lb capacity, 100% extension;

Heavy-duty construction;

Easy to install;

Vast choice of accessories offered to adapt to your storage needs;

Available drawer heights: 3", 4", 5", 6", 7", 8", 9", 10", 12" and 14";

Order by adding the drawer height to the part #  
Ex.: RF31-302706;

For modular drawers with layouts,

| Product # | W x D     |
|-----------|-----------|
| RF31-2421 | 24" x 21" |
| RF31-2427 | 24" x 27" |
| RF31-3021 | 30" x 21" |
| RF31-3027 | 30" x 27" |

SEE  
PAGES  
157-161

SEE  
PAGES  
143-156

### Heavy-Duty Front Access Roll-Out Shelf

RF40



400 lb capacity, 100% extension;

Heavy-duty construction;

Easy to install;

Painted steel with 3" edges on sides and back;

Height: 6";

Full access to contents.

**Product #**      **W x D**

RF40-2421      24" x 21"

RF40-2427      24" x 27"

RF40-3021      30" x 21"

RF40-3027      30" x 27"

### Heavy-Duty 3-Sided Access Roll-Out Shelf

RF44



400 lb capacity, 100% extension;

Heavy-duty construction;

Easy to install;

Galvanized steel with 1 1/2" edge on back;

Height: 5";

May serve as work surface.

| Product # | W x D     |
|-----------|-----------|
| RF44-2421 | 24" x 21" |
| RF44-2427 | 24" x 27" |
| RF44-3021 | 30" x 21" |
| RF44-3027 | 30" x 27" |

### Integrated Lock-In Mechanism



A



Activated by tilting the handle up;

Allows user to open the drawer and the roll-out shelf with one hand only;

Close by simply pushing it;

Stops drawer and roll-out shelf from opening on their own;

Easy to retrofit;

Order by adding A to the drawer or partitioning model number or roll-out shelf.

Ex.: RF31-302706A;

For replacement parts or to retrofit this mechanism, order RY08-XXA.

**Product #**

A

### Lock-Out Mechanism

RF85



For both drawers and roll-out shelves;

Locks drawers and roll-out shelves in open position;

Activated manually, only when required;

Compatible with all accessories drawer;

Plastic bins positioned in the back row, may make it more difficult to activate mechanism.

**Product #**

RF85

### Econo Lock-In Mechanism

B

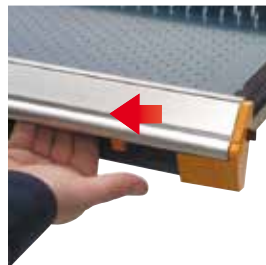

Activated with the right hand by sliding the mechanism with thumb;

Drawer and roll-out shelf close without having to reactivate the slide mechanism;

Stops drawer and roll-out shelf from opening on their own;

Easy to retrofit;

Order by adding B to the drawer or partitioning model number or roll-out shelf.

Ex.: RF31-302706B;

For replacement parts or to retrofit this mechanism, order RY01-B.

**Product #**

B

### Handle Protector

RF70



Clips onto the drawer handle;

Made of transparent plastic;

Protects identification labels on drawers from dust, grease and other debris;

Easy to remove when required;

Labels sold separately.

**Product #**      **Width**

RF70-24      24"

RF70-30      30"

SEE  
PAGE  
158

### Drawer Lock

L3

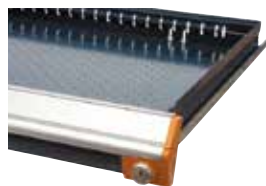

Compatible with all drawer dimensions;

Does not affect usable drawer space;

Easy to retrofit;

Order by adding L3 to drawer or partitioning model number. Ex.: RF31-302706L3;

For replacement parts or to retrofit this mechanism, order RY01-L3.

**Product #**

L3



SEE  
PAGE  
194

# Components - Structure Under the Work Surface

## Doors

### Single Integrated Door, Solid or Polycarbonate

**IMPROVED** RB32 / RB31

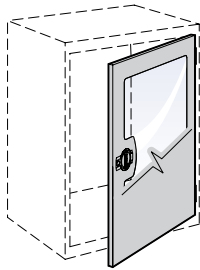

Integrated door: RB32;  
Polycarbonate integrated door: RB31;  
Compatible with RB23/RB25 bottom shelf and RB22/RB24 adjustable shelf;  
Opens 180° for full access to items stored inside;  
Factory installed on RA30 cabinet housings;  
Standard lock included;

Some heights may be combined with drawers mounted above or below. In the latter case, you must order a RB22 or RB24 adjustable shelf for installation above the section of drawers;

Order by specifying the type of door.  
Ex.: RB31-3034L3 for 30" W x 34" H polycarbonate integrated door;

Note: Not compatible with RF31 drawer or RF40/RF44 roll-out shelf;

Note: Integrated door (RB32) has a finished back for increased rigidity and aesthetics;

Note: Polycarbonate integrated door (RB31) is impact resistant.



### Double Integrated Doors, Solid or Polycarbonate

**IMPROVED** RB37/ RB36

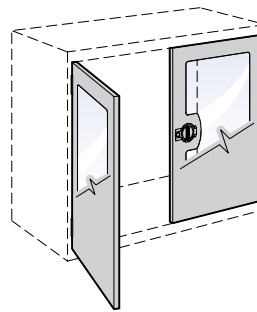

Integrated doors: RB37;  
Polycarbonate integrated doors: RB36;  
Compatible with RB24 adjustable shelf;  
Opens 180° for full access to items stored inside;  
Factory installed on RA30 cabinet housings;  
Standard lock included;

Some heights may be combined with drawers mounted above or below. In the latter case, you must order a RB24 adjustable shelf for installation above the section of drawers, or a crossbar for drawers mounted above;

Order by specifying the type of door.  
Ex.: RB36-3020L3 for 30" W x 20" H polycarbonate integrated doors;

Note: Not compatible with RB25 bottom shelf;

Note: Not compatible with RF31 drawer or RF40/RF44 roll-out shelf;

Note: Integrated door (RB37) has a finished back for increased rigidity and aesthetics;

Note: Polycarbonate integrated doors (RB36) are impact resistant.

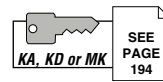

| Product #  | W x H     |
|------------|-----------|
| RB_-2420L3 | 24" x 20" |
| RB_-2424L3 | 24" x 24" |
| RB_-2426L3 | 24" x 26" |
| RB_-2430L3 | 24" x 30" |
| RB_-2434L3 | 24" x 34" |
| RB_-3020L3 | 30" x 20" |

| Product #  | W x H     |
|------------|-----------|
| RB_-3024L3 | 30" x 24" |
| RB_-3026L3 | 30" x 26" |
| RB_-3030L3 | 30" x 30" |
| RB_-3034L3 | 30" x 34" |
| RB_-3040L3 | 30" x 40" |
| RB_-3054L3 | 30" x 54" |

| Product #  | W x H     |
|------------|-----------|
| RB_-3020L3 | 30" x 20" |
| RB_-3024L3 | 30" x 24" |
| RB_-3026L3 | 30" x 26" |
| RB_-3030L3 | 30" x 30" |
| RB_-3034L3 | 30" x 34" |
| RB_-3040L3 | 30" x 40" |
| RB_-3054L3 | 30" x 54" |

### Crossbar for Double Integrated Doors

**RB70**

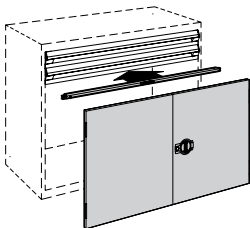

Required for double integrated doors with drawer above.

| Product # | Width |
|-----------|-------|
| RB70-30   | 30"   |



## Sink Cabinets

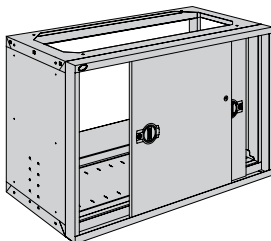

The top has an opening to allow for installation of a sink;

Has an opening on the back on the housing to allow for installation of a drain and pipes;

1 bottom shelf;

Models that have a door with frame are compatible with drawers and roll-out shelves;

Standard lock included;

Compatible with bases;

Heights available: 28", 30" and 34";

Complete the part # with height wanted and by referring to chart below for door types;

Ex.: R5TDD-28\_01;

Note: Sink is not included;

SEE PAGE 112



Note: Work surfaces must be ordered separately (cut-outs are not provided by Rousseau).

SEE PAGE 100

| Product #           | W x D |
|---------------------|-------|
| R5TDD-__* 30" x 21" |       |
| R5TDG-__* 30" x 27" |       |
| R5THD-__ 48" x 21"  |       |
| R5THG-__ 48" x 27"  |       |



|    |   |
|----|---|
| 01 | For cabinet with single integrated door   |
| 02 | For cabinet with double integrated doors  |
| 03 | For cabinet with double doors with frame  |
| 04 | For cabinet with integrated sliding doors |
| 05 | For cabinet with sliding doors with frame |

\*Models are not compatible with sliding doors.

# Components – Structure Above the Work Surface

## Riser Shelves

### Painted Steel

### WS50



Thickness: 1 ¼";  
May be installed on all types of shelf supports;  
True width = nominal width – 3".

### Laminated Wood

### WS51



Made from varnished hardwood slats;  
Thickness: 1 ¼";  
May be installed on WS54, WS55, WS59 and WM27-1202 shelf supports;  
Attractive appearance.

### Plastic Laminated

### WS52



Color: White;  
Thickness: 1 ¼";  
May be installed on WS54, WS55, WS59 and WM27-1202 shelf supports;  
Attractive appearance.

### Dissipative

### WS53



Dissipates electric charges that can damage electronic components;  
Resistance point to point and point to ground between 10<sup>9</sup> and 10<sup>9</sup> Ω;  
Color: White;  
Thickness: 1 ¼";  
May be installed on WS54, WS55, WS59 and WM27-1202 shelf supports.

### Stainless Steel

### WS56



Thickness: 1 ¼";  
Brushed finish # 4;  
May be installed on all types of shelf supports;  
True width = nominal width – 3".

### Resistant Acrylic/PVC Plastic Laminated

### WS57



Color: Gray;  
Thickness: 1 ¼";  
May be installed on WS54, WS55, WS59 and WM27-1202 shelf supports.

| Dimensions |     | Type of Shelf |                |                   |             |                 |                       |
|------------|-----|---------------|----------------|-------------------|-------------|-----------------|-----------------------|
| W          | D   | Painted Steel | Laminated Wood | Plastic Laminated | Dissipative | Stainless Steel | Acrylic/PVC Laminated |
| 48"        | 12" | WS50-4812 *   | WS51-4812      | WS52-4812         | WS53-4812   | WS56-4812       | WS57-4812             |
| 60"        | 12" | WS50-6012 *   | WS51-6012 *    | WS52-6012 *       | WS53-6012 * | WS56-6012       | WS57-6012*            |
| 72"        | 12" | WS50-7212 *   | WS51-7212 *    | WS52-7212 *       | WS53-7212 * | WS56-7212       | WS57-7212*            |

**NOTE** \*Stock items. Other models are available on manufacturing schedules only.

### Riser Shelf Supports

### WS54

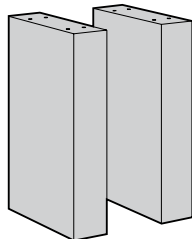

Sold in pairs;  
Accommodate WS50 (12" D), WS51, WS52, WS53, WS56, WS57 shelves;  
Height: 16";  
Attractive appearance.

| Product # | W x D x H        |
|-----------|------------------|
| WS54-16   | 3" x 10 ¼" x 16" |

### Riser Shelf Supports with Electrical Outlets on Both Sides

### WS55

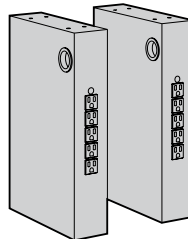

Sold in pairs;  
Each support is equipped with a power strip with 5 outlets;  
Accommodate WS50 (12" D), WS51, WS52, WS53, WS56, WS57 shelves;  
Height: 16";  
Attractive appearance.

| Product # | W x D x H        |
|-----------|------------------|
| WS55-16   | 3" x 10 ¼" x 16" |

### Riser Shelf Supports with Electrical Outlets on One Side

### WS59

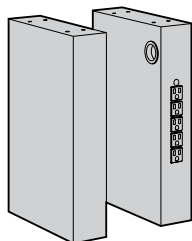

Sold in pairs;  
One support is equipped with a power strip with 5 outlets;  
Accommodate WS50 (12" D), WS51, WS52, WS53, WS56, WS57 shelves;  
Height: 16";  
Attractive appearance.

| Product # | W x D x H        |
|-----------|------------------|
| WS59-16   | 3" x 10 ¼" x 16" |

### Econo Riser Shelf Supports

### WS82

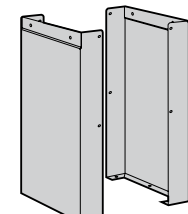

Sold in pairs;  
Permit installation of one or two shelves (12" D);  
Accommodate WS50 and WS56 shelves only;  
Total height: 16";  
Mid-height shelf: 8";  
Easy to assemble.

| Product # | Height |
|-----------|--------|
| WS82-1601 | 16"    |

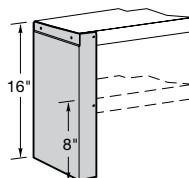



# Components – Structure Above the Work Surface

## Shelf Back or Front Stop

WS58 / WS99

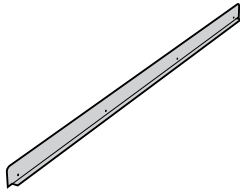

Painted steel: WS58;  
Stainless steel: WS99;  
May be attached to WS50, WS51, WS52, WS53, WS56, WS57 shelves;  
Prevents objects from falling from fixed or adjustable riser shelves;  
Clears shelf by 1";  
To order, complete product # with steel choice needed. Ex.: WS58-48 for painted steel.

| Product # | W x H        | For Shelf |
|-----------|--------------|-----------|
| WS_-48    | 45" x 2 1/4" | 48" W     |
| WS_-60    | 57" x 2 1/4" | 60" W     |
| WS_-72    | 69" x 2 1/4" | 72" W     |

## Back Panel for Riser Shelf

WS83 / WS93

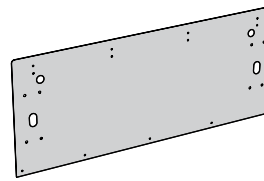

Painted steel: WS83;  
Stainless steel: WS93;  
Mounted at the back of the work area and the riser shelf;  
May be mounted on all surfaces or on any shelf;  
Holes for cables;  
Height: 20". Exceeds the riser shelf to prevent objects from falling;  
To order, complete product # with steel choice needed. Ex.: WS83-4616 for painted steel.

| Product # | Width |
|-----------|-------|
| WS_-4816  | 48"   |
| WS_-6016  | 60"   |
| WS_-7216  | 72"   |

## Lighting Fixture for Riser Shelf

WS84

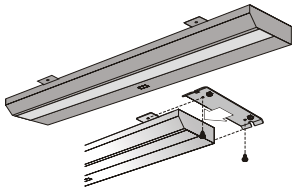

Eliminates shaded areas beneath riser shelves;  
May be mounted on all types of riser shelves;  
Adaptors for WS50 steel riser shelf included;  
T8 fluorescent tube included;  
Includes K12 acrylic outlet, 10' power cord and switch;  
Color: Black;  
T8 ballast as energy saver.

| Product # | For Shelves  |
|-----------|--------------|
| WS84-36T8 | 48" and over |
| WS84-48T8 | 60" and over |



WSC2017



# Components - Structure Above the Work Surface

## Electronic Applications

### Power Outlet Strip

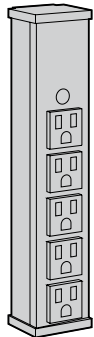

15A strip equipped with breakers and 6' extension cord;

Mounted horizontally beneath the work surface or the riser shelf;

Installation hardware included.

| Product # | H   | No. of Outlets          |
|-----------|-----|-------------------------|
| 70000500  | 9"  | 5 Without on/off switch |
| 70000505  | 12" | 6 With on/off switch    |
| 70000520  | 48" | 8 With on/off switch    |



LC3004C

### Grounding Block

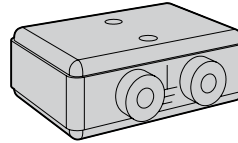

2 outlets for ground wrist strap;

Comes with 10' long grounding cord;

Dissipates electric charges that could damage electronic components.

**Product #**  
70000350

### Grounding Cord

### WS89

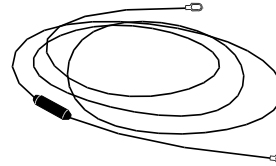

Links dissipative top or shelf to grounding block or directly to ground;

Dissipates electric charges that could damage electronic components;

10' long.

**Product #**  
70000300 Used to ground workstation. 1M  $\Omega$  resistance.  
WS89-01 Used to ground all components on the workstation to a common grounding point.

### Ground Wrist Strap

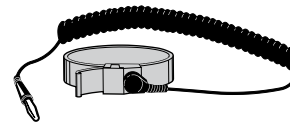

Stretch material;

6' cable;

Dissipates electric charges that could damage electronic components; 1M  $\Omega$  resistance.

**Product #**  
70000320



### Conductive Plastic Bin



### RG21

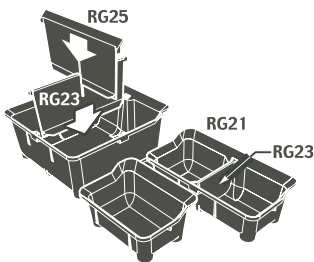

Dissipates electric charges that could damage electronic components;

Color: Black;

Makes storing, moving and inventory of small parts easier. Lightweight and resistant;

Compatible with WM55 louvered panel, WM28 plastic bin rail and 3" and 4" high drawers;

Edge at 45° angle for easy identification and easy removal of parts;

6" bins can be divided.



| Dimensions |    |    | Product #   |           |           |
|------------|----|----|-------------|-----------|-----------|
| W          | D  | H  | Bin         | Partition | Divider   |
| 3"         | 3" | 2" | RG21-030302 | -         | -         |
| 4"         | 3" | 2" | RG21-040302 | -         | -         |
| 6"         | 3" | 2" | RG21-060302 | RG23-0302 | -         |
| 6"         | 6" | 2" | RG21-060602 | RG23-0602 | RG25-0602 |
| 3"         | 3" | 3" | RG21-030303 | -         | -         |
| 4"         | 3" | 3" | RG21-040303 | -         | -         |
| 6"         | 3" | 3" | RG21-060303 | RG23-0303 | -         |
| 6"         | 6" | 3" | RG21-060603 | RG23-0603 | RG25-0603 |

# Components - Structure Above the Work Surface

## Multi-Purpose Frame Components

### Multi-Purpose Upright

WM10

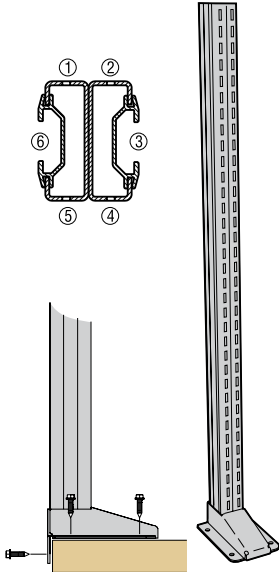

May be installed on most workbench tops offered on the market. Requires a good quality top, at least 1 1/2" thick;

Characterized by its shape and rigidity;

Offers up to six fixing zones for a minimum of interference between components;

Perforated on front and back faces at 1" c/c intervals for optimum adjustment of accessories ① ② ④ ⑤;

Features two black aluminum extrusions on the sides for infinitely adjustable accessories ③ ⑥;

Five anchor points on the foot ensure stability on the two main axes;

Symmetrical shape means the upright may be used for back-to-back workstations;

The 48" height is ideal for overhead accessories.

| Product # | Height |
|-----------|--------|
| WM10-24   | 24"    |
| WM10-36   | 36"    |
| WM10-48   | 48"    |

### Top Flange for WM11 Frame - 28" / 56" W

WS18 / WS98

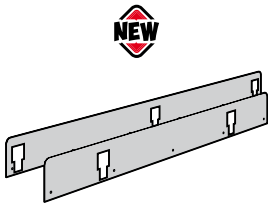

Painted steel: WS18;

Stainless steel: WS98;

Designed specifically to be compatible with the WM11 frame of 28" and 56" wide;

Installs on all types of tops;

Height: 5". Exceeds top by approx. 3 1/4";

Designed for an upright that is centered on the workstation;

Specify type of steel to place order. Ex.: WS18-480502 for a top flange in painted steel for a WM11 frame measuring 28" wide with 2 uprights.

| Product #  | Width | Application       |
|------------|-------|-------------------|
| WS_-360502 | 36"   | For 2 WM uprights |
| WS_-480502 | 48"   | For 2 WM uprights |
| WS_-600502 | 60"   | For 2 WM uprights |
| WS_-600503 | 60"   | For 3 WM uprights |
| WS_-720502 | 72"   | For 2 WM uprights |
| WS_-720503 | 72"   | For 3 WM uprights |

### Upright Cross Member

WM15

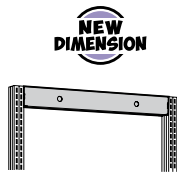

Strengthens unit frames;

Hooks onto WM10 uprights and can be secured in place;

Includes two knockouts for pneumatic connectors.

| Product # | Width (c/c) |
|-----------|-------------|
| WM15-28   | 28"         |
| WM15-34   | 34"         |
| WM15-56   | 56"         |
| WM15-68   | 68"         |

### Cantilever Overhead Supports

WM18

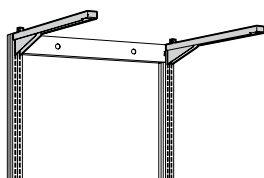

Sold in pairs;

Clip onto WM10 uprights;

Lock in place with a safety latch located on the top of the support;

Capacity: are designed to hold a WM45 overhead workstation light and one WM47 tool rail, or two WM47 tool rails.

| Product # | Depth | Color |
|-----------|-------|-------|
| WM18-26   | 26"   | Black |

### WM Unit Frame

NEW DIMENSION WM11

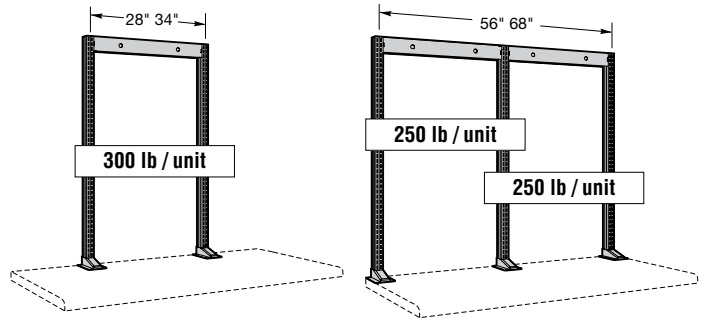

The single unit frame consists of:  
- 2 WM10 uprights  
- 1 WM15 upright cross member

Capacity: 300 lb per unit frame.

| Product # | W x H     | W Required |
|-----------|-----------|------------|
| WM11-2836 | 28" x 36" | 36" min.   |
| WM11-2848 | 28" x 48" | 36" min.   |
| WM11-3436 | 34" x 36" | 48" min.   |
| WM11-3448 | 34" x 48" | 48" min.   |

The double unit frame consists of:  
- 3 WM10 uprights  
- 2 WM15 upright cross members

Capacity: 250 lb per unit frame (Total: 500 lb).

| Product # | W x H     | W Required |
|-----------|-----------|------------|
| WM11-5636 | 56" x 36" | 60" min.   |
| WM11-5648 | 56" x 48" | 60" min.   |
| WM11-6836 | 68" x 36" | 72" min.   |
| WM11-6848 | 68" x 48" | 72" min.   |

### Top Flange for WM11 Frame - 34" / 68" W

NEW WS1A / WS91

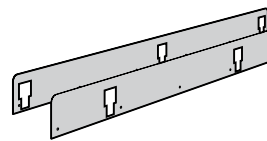

Top flange in painted steel: WS1A;

Top flange in stainless steel: WS91;

Designed specifically to be compatible with the WM11 frame measuring 34" and 68" wide;

Installs on all types of tops;

Height: 5". Exceeds top by approx. 3 1/4";

Designed for an upright that is centered on the workstation.

Specify the type of steel to place order. Ex.: WS1A-480502 for a top flange in painted steel for a WM11 frame measuring 34" wide with 2 uprights.

| Product no. | Width | Application       |
|-------------|-------|-------------------|
| WS_-480502  | 48"   | For 2 WM uprights |
| WS_-600502  | 60"   | For 2 WM uprights |
| WS_-720502  | 72"   | For 2 WM uprights |
| WS_-720503  | 72"   | For 3 WM uprights |

### Top Reinforcer

WM14

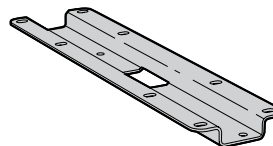

Required for work tops less than 1 1/2" thick, in poor condition or back-to-back workstations;

Used to strengthen the anchor points of the WM10 upright;

Fastened to the underside of the work surface.

| Product # | W x D    | Color |
|-----------|----------|-------|
| WM14-01   | 4" x 16" | Black |

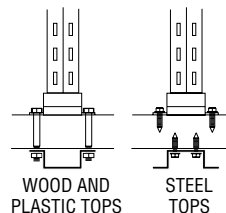

Recommended with work tops other than Rousseau's.

# Components - Structure Above the Work Surface

WORK CENTER

## Multi-Purpose Wall Mounted Frame

WM35

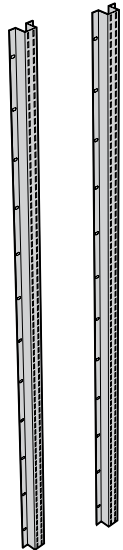

300 lb capacity (wall and wall anchoring must be strong enough);

Up to 500 lb capacity for a combination of 3 uprights;

Perforated on front face at 1" c/c intervals for optimum adjustment of accessories;

Wall anchoring not included;

Compatible accessories (space between uprights must be 28" or 34" c/c):

- WM18 cantilever overhead supports
- WM20 tiltable shelf
- WM22 tiltable pan
- WM27 structural shelf supports
- WM28 plastic bin rail
- WM31 wire spool support
- WM40 power outlet channel
- WM55 louvered panel for plastic bins
- WM75 storage cabinet
- RD00 wall cabinet (with RD08 adaptors)
- WM Adaptor NC50 (with tool rack NC10 / NC12)



| Product # | Height | Number of Uprights |
|-----------|--------|--------------------|
| WM35-7201 | 72"    | 1                  |
| WM35-7202 | 72"    | 2                  |
| WM35-7203 | 72"    | 3                  |

## Wall Mounted Perforated Panel

WM51 / WM56

Perforated panel for the WM35 wall mounted frame: WM51;

Perforated panel for hanging directly on the wall: WM56;

Painted steel perforated every 1" c/c;

Used to hang accessories or tools.

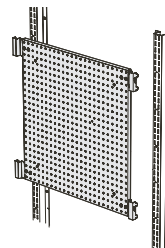

| Product # | W x H     | Model          |
|-----------|-----------|----------------|
| WM51-2424 | 24" x 24" | For WM35 frame |
| WM51-2436 | 24" x 36" | For WM35 frame |
| WM56-2424 | 24" x 24" | Wall mounted   |
| WM56-2436 | 24" x 36" | Wall mounted   |
| WM56-2472 | 24" x 72" | Wall mounted   |

## Tiltable Shelf



WM20

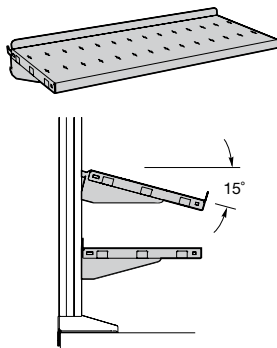

Clips onto WM10 uprights;

Slotted to receive SH52 dividers at every 2" c/c; Includes 2 side supports that may be placed at right angles or at an angle of 15°;

The shelf is reversible and its edge may serve as a back stop for plastic bins or binders;

Capacity: 100 lb, evenly distributed load.

| Product # | W x D     |
|-----------|-----------|
| WM20-2808 | 28" x 8"  |
| WM20-2812 | 28" x 12" |
| WM20-3408 | 34" x 8"  |
| WM20-3412 | 34" x 12" |

## Partial Divider



SH52

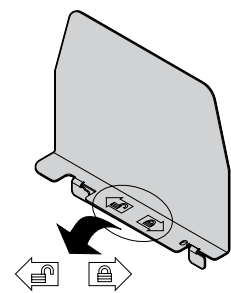

Unique patented divider;

May be used with WM20 8" and 12" deep shelves; adjustable every 2" c/c;

Installed in the shelf slots, forward or backward.

| Product # | D x H   |
|-----------|---------|
| SH52-1206 | 8" x 6" |

Pictograms to facilitate installation

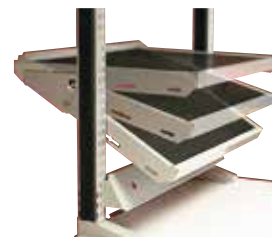



# Components - Structure Above the Work Surface

WORK CENTER

## Shelf



### WS50 / 51 / 52 / 53 / 56 / 57



Installed on WM10 uprights with WM27 shelf supports;

Capacity: 200 lb;  
Possible to add WS58 or WS99 shelf back or front stop;  
Thickness: 1 1/4".

| Product # | W x D         | Type of Shelf         |
|-----------|---------------|-----------------------|
| WS50-6012 | 56 3/4" x 12" | Steel                 |
| WS51-6012 | 60" x 12"     | Laminated wood        |
| WS52-6012 | 60" x 12"     | Plastic laminated     |
| WS53-6012 | 60" x 12"     | Dissipative           |
| WS56-6012 | 56 3/4" x 12" | Stainless steel       |
| WS57-6012 | 60" x 12"     | Acrylic/PVC laminated |
| WS50-7212 | 68 3/4" x 12" | Steel                 |
| WS51-7212 | 72" x 12"     | Laminated wood        |
| WS52-7212 | 72" x 12"     | Plastic laminated     |
| WS53-7212 | 72" x 12"     | Dissipative           |
| WS56-7212 | 68 3/4" x 12" | Stainless steel       |
| WS57-7212 | 72" x 12"     | Acrylic/PVC laminated |

## Structural Shelf Supports

### WM27

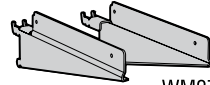

WM27-1201

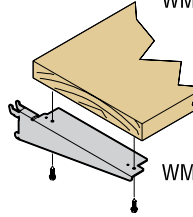

WM27-1202

Sold in pairs;  
Clip onto WM10 uprights;  
Used with all types of 48", 60" or 72" wide shelves;  
May be positioned at a right angle or inclined at an angle at 15°.

| Product # | Depth for Shelves          |
|-----------|----------------------------|
| WM27-1201 | 12" WS50, WS56             |
| WM27-1202 | 12" WS51, WS52, WS53, WS57 |

## Sliding Divider

### WS87

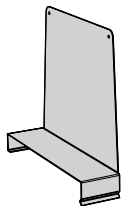

Clips onto a 12" deep WS50 steel shelf installed above or below the work surface;

Not compatible for use with WS58 shelf with a back or front stop.

| Product # | D x H     |
|-----------|-----------|
| WS87-1210 | 12" x 10" |

## Tiltable Pan



### WM22

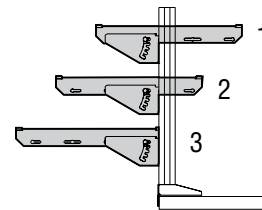
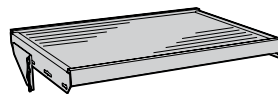

Clips onto WM10 uprights;  
Three positions: front, center and back;  
Unique feature: may be easily tilted from 0 to 30° with 5 adjustment positions;  
Full-size rubber mat included;  
Usable space: 24 1/2" x 18 1/2" (28" x 20");  
Usable space: 30 1/2" x 18 1/2" (34" x 20");  
Capacity: 200 lb.

| Product # | W x D     |
|-----------|-----------|
| WM22-2820 | 28" x 20" |
| WM22-3420 | 34" x 20" |

## Plastic Bin Rail



### WM28

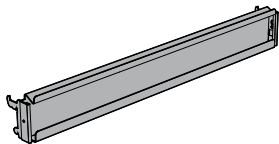

Clips onto the WM10 uprights; adjustment every 1" c/c;

Suited to all makes of plastic bins with hanger lip sold on the market;

Can receive all sizes of RG20 plastic bins;

Capacity: 75 lb, evenly distributed load.

SEE PAGE 120

| Product # | Width |
|-----------|-------|
| WM28-2801 | 28"   |
| WM28-3401 | 34"   |



## Tool Support

### WM30

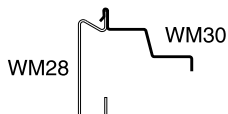
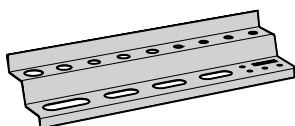

Made of galvanized steel;  
Installs on WM20 shelf, WM28 plastic bin rail or on WM62 monitor tray;  
Features holes of several sizes to hang tools.

| Product # | Width |
|-----------|-------|
| WM30-01   | 12"   |

## Wire Spool Support



### WM31

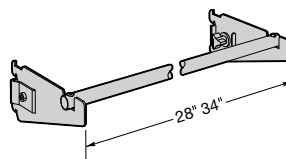

Includes 2 side supports and a 3/4" diameter rod;  
Capacity: 50 lb.

| Product # | Width |
|-----------|-------|
| WM31-2801 | 28"   |
| WM31-3401 | 34"   |



# Components - Structure Above the Work Surface

WORK CENTER

## Plastic Bin



## RG20



Make storing, moving and inventory of small parts easier. Lightweight and resistant;  
Edge at 45° angle for easy identification and easy grasp of bins;  
Compatible with WM55 louvered panel, WM28 and WM9C plastic bin rail;  
6" bins can be divided.

| Dimensions |    |    | Product #   |           |           |
|------------|----|----|-------------|-----------|-----------|
| W          | D  | H  | Bin         | Partition | Divider   |
| 3"         | 3" | 2" | RG20-030302 | -         | -         |
| 4"         | 3" | 2" | RG20-040302 | -         | -         |
| 6"         | 3" | 2" | RG20-060302 | RG22-0302 | -         |
| 6"         | 6" | 2" | RG20-060602 | RG22-0602 | RG24-0602 |
| 3"         | 3" | 3" | RG20-030303 | -         | -         |
| 4"         | 3" | 3" | RG20-040303 | -         | -         |
| 6"         | 3" | 3" | RG20-060303 | RG22-0303 | -         |
| 6"         | 6" | 3" | RG20-060603 | RG22-0603 | RG24-0603 |

## Paper and Cardboard Spool Support

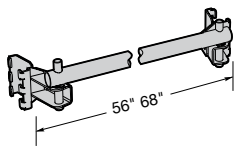

Installs on WM10 uprights to create a packaging station;  
Includes two end brackets and one rod;  
Rod diameter: 1";  
One person alone may insert the spool by pivoting one end of the rod;  
Color: Black;  
Capacity: 75 lb.

| Product # | Width |
|-----------|-------|
| WM86-56   | 56"   |
| WM86-68   | 68"   |

## Tool Rail



## WM47

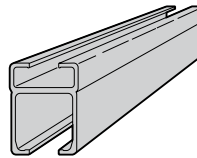

Allows the installation of one or more WM48 balancer trolley;  
Installs on WM18 cantilever overhead supports (sold separately);  
Easily adjustable depth;  
Color: Black;  
Capacity: 25 lb.

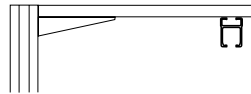

| Product # | Width | c/c intervals   |
|-----------|-------|-----------------|
| WM47-4801 | 48"   | 28" / 34"       |
| WM47-6001 | 60"   | 28" / 34" / 56" |
| WM47-6002 | 60"   | 68"             |

## Joiner for Tool Rail

## WM89

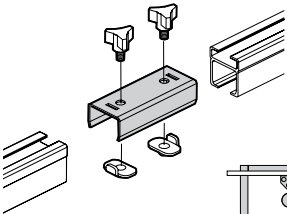

Allows assembly of two WM47 tool rails on adjacent workstations.  
Product #  
WM89-01

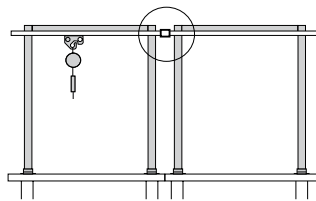

## Balancer Trolley

## WM48



Inserts into the WM47 tool rail;  
Color: Black;  
Can receive a pneumatic connector.  
Product #  
WM48-01

## Tool Balancer

## WM49

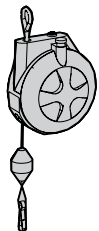

Allows hanging of tools overhead, above the work surface;  
Six foot metal cable with tension adjustment;  
Color: Black;  
Capacity: up to 3 lb.  
Product #  
WM49-01



LC3012C



# Components – Structure Above the Work Surface

## Computer Supports for Work Surface

### Laptop Support

**RC58-01**



Can be used for a laptop computer or an electronic device etc;  
 Usable tray surface 14" W X 12" D;  
 Can be installed on the work surface using the finishing module for the computer support (RC68/ RC69) or directly on the surfaces: WS08, WS14, WS16, WS17, RC35, RC36 and RC37;  
 Not compatible with the WS10 and WS12 work surfaces;  
 Stainless steel upright, 17" H;  
 Arm, adaptor and tray in painted steel. Color: Black;  
 The tray for laptop is adjustable at 13" height to accommodate different users;  
 The tray is equipped with non-slip strips (Velcro®) to ensure the laptop doesn't slide.

**Product #**  
 RC58-01

### LCD Monitor Support

**RC57-01**



Can be used to support most LCD monitors available on the market ;  
 Can be installed on the work surface using the finishing module for the computer support (RC68/ RC69) or directly on the surfaces: WS08, WS14, WS16, WS17, RC35, RC36 and RC37;  
 Not compatible with the WS10 and WS12 work surfaces;  
 Stainless steel upright, 17" H;  
 Arm and adapter in painted steel. Color: Black;  
 The LCD monitor support is adjustable at 13" height to accommodate different monitor dimensions and different users;  
 Positioning of monitor anchors according to VESA 75 and 100 standards.

**Product #**  
 RC57-01

### LCD Monitor, Keyboard and Mouse Support

**RC58-02**



Can be installed on the work surface using the finishing module for the computer support (RC68/ RC69) or directly on the surfaces: WS08, WS14, WS16, WS17, RC35, RC36 and RC37;  
 Not compatible with the WS10 and WS12 work surfaces;  
 Stainless steel upright, 17" H;  
 Arm, adaptor and tray in painted steel. Color: Black;  
 The keyboard and mouse tray is adjustable at 13" height to accommodate different users;  
 Usable surface of the keyboard and mouse tray : 23 3/8" W x 8 1/2" D;  
 The LCD monitor support is adjustable at 13" height to accommodate different monitor dimensions and different users;  
 Can support most LCD monitors available on the market;  
 Positioning of monitor anchors according to VESA 75 and 100 standards.

**Product #**  
 RC58-02

### Double LCD Monitor Support

**RC57-03**



Can be used to support two LCD monitors ;  
 Can be installed on the work surface using the finishing module for the computer support (RC68/ RC69) or directly on the surfaces: WS08, WS14, WS16, WS17, RC35, RC36 and RC37;  
 Not compatible with the WS10 and WS12 work surfaces;  
 Stainless steel upright, 17" H;  
 Arm and adapter in painted steel. Color: Black;  
 The LCD monitor support is adjustable at 13" height to accommodate different monitor dimensions and different users;  
 Positioning of monitor anchors according to VESA 75 and 100 standards.

**Product #**  
 RC57-03

## Light-Duty Arm for Multi-Purpose Frames

### Light-Duty Arm Adaptor

**WM68**

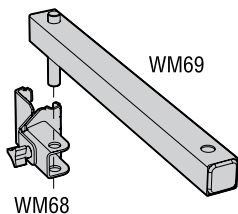

Quick assembly on WM10 uprights;  
 Allows the attachment of different makes of lamps or document holders with a 1/2" diameter rod pivot;  
 Capacity: 20 lb.

**Product #**      **Color**  
 WM68-01      Black

### Light-Duty Arm

**WM69**

Attaches to the WM68 light-duty arm adaptor to extend the range of a document holder or lamp pivoting on a 1/2" diameter rod;  
 Capacity: 20 lb.

**Product #**      **Width**      **Color**  
 WM69-12      12"      Black

### Document Holder with Arm

**WM70**

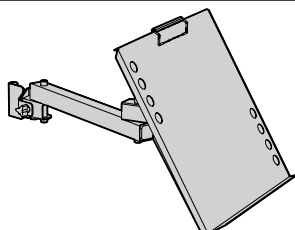

Includes a WM68 light-duty arm adaptor and a 12" WM69 light-duty arm;  
 The document holder (14" x 13 1/2") features a paper clip and edge on which to rest binders;  
 Capacity: 20 lb.

**Product #**      **Color**  
 WM70-01      Black



# Components - Structure Above the Work Surface

## Computer Supports for Multi-Purpose Frames

### Standard Monitor Tray

### WM62 / WM64

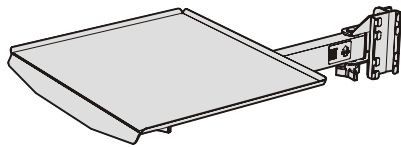

May be used to hold a computer monitor, laptop computer, electronic device or any other object;

Usable tray space: 16" W x 13 7/8" D;

Includes one 18" heavy-duty arm with single or double articulation and a non-slip rubber mat;

The double articulated model allows for increased adjusting possibilities;

Compatible with the WM63 keyboard and mouse tray;

50 lb capacity (wall mounted version: the wall and wall anchoring must be strong enough);

Color: Black;

Wall anchoring not included for the wall mounted model.

| Product # | Articulating Arm | Model          |
|-----------|------------------|----------------|
| WM62-01A  | Single           | For WM11 frame |
| WM62-02A  | Double           | For WM11 frame |
| WM64-01A  | Single           | Wall mounted   |
| WM64-02A  | Double           | Wall mounted   |



### Keyboard and Mouse Tray

### WM63

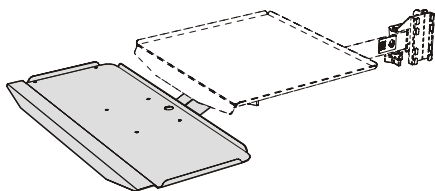

Installs on the WM62 and WM64 monitor tray with arm;

Color: Black;

Usable tray space: 23 1/16" W x 8 1/2" D.

Product #

WM63-2402

### LCD Monitor Holder

### WM65 / WM66

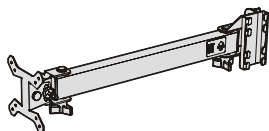

Can be used to hold the majority of LCD monitors on the market;

Screen anchor support respects VESA 75 & 100 standards;

Possible to tilt the screen;

Color: Black;

Note: Not compatible with the keyboard tray.

| Product # | Articulating Arm | Model          |
|-----------|------------------|----------------|
| WM65-01A  | Single           | For WM11 frame |
| WM65-02A  | Double           | For WM11 frame |
| WM66-01A  | Single           | Wall mounted   |
| WM66-02A  | Double           | Wall mounted   |

### LCD Monitor and Keyboard Holder

### WM65 / WM66

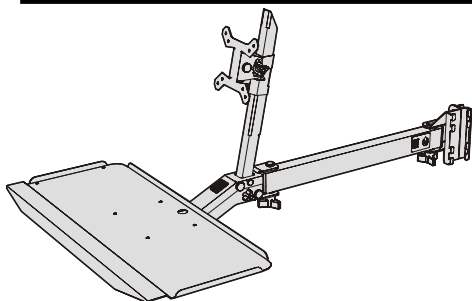

Can be used to hold the majority of LCD monitors on the market;

Screen anchor support respects VESA 75 & 100 standards;

Includes a keyboard holder, usable surface is 23 1/16" W x 8 1/2" D;

Color: Black;

Screen can be adjusted in height, and can also be tilted.

| Product # | Articulating Arm | Model          |
|-----------|------------------|----------------|
| WM65-01B  | Single           | For WM11 frame |
| WM65-02B  | Double           | For WM11 frame |
| WM66-01B  | Single           | Wall mounted   |
| WM66-02B  | Double           | Wall mounted   |

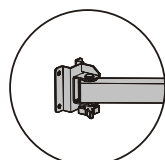

Wall Mounted

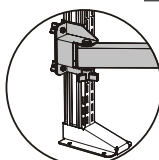

For WM11 Frame

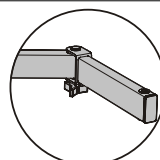

Double Articulating Arm



# Components – Structure Above the Work Surface

## Privacy Panel and Perforated Panel



WM52 / WM53

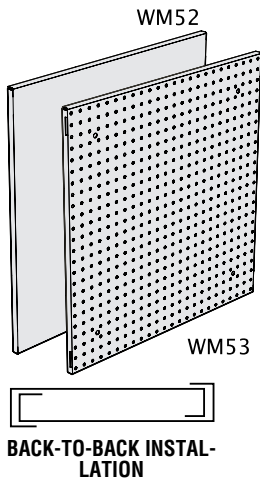

Painted steel WM52;  
Used to close the multi-purpose frame at the back;  
Painted steel perforated every 1" c/c WM53;  
Used to hang accessories or tools;  
WM50 panel bracket kit must be ordered separately (1 kit per panel or for 2 back-to-back panels);  
- 24" H panel may be installed on 36" H and 48" H uprights  
- 36" H panel must be installed on 48" H uprights only;  
Note: 24" W panel must be installed on 28" c/c uprights;  
Note: 30" W panel must be installed on 34" c/c uprights.

| Product # | W x H     | Product # | W x H     |
|-----------|-----------|-----------|-----------|
| WM52-2424 | 24" x 24" | WM52-3024 | 30" x 24" |
| WM52-2436 | 24" x 36" | WM52-3036 | 30" x 36" |
| WM53-2424 | 24" x 24" | WM53-3024 | 30" x 24" |
| WM53-2436 | 24" x 36" | WM53-3036 | 30" x 36" |



WORK CENTER

## Vinyl Rub-on Identification Decal

WM91



Allows you to easily identify where tools are to be positioned on the perforated panels;  
The contrasting color provides fast retrieval and shows if tools are missing, and which ones;  
Efficient help for 5S management;  
Sold in rolls 2 feet wide and 8 feet long.

SEE PAGES 130-131

**Product #**  
WM91-01J

## Panel Bracket Kit



WM50

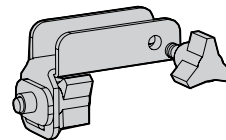

Includes 4 brackets;  
Required for installation of WM52, WM53 and WM54 panels;  
Easy assembly on WM10 upright sides, no tools required.

**Product #**      **Color**  
WM50-01          Black

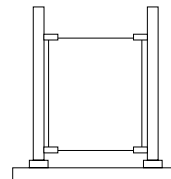

## Multiple Tool Holder

WM94



Used for WM51, WM53, WM56 and WM57 perforated panels to hang accessories or tools.

**Product #**      **W x H**  
WM94-01          9" x 1 1/2"

## Straight Arm Hooks

WM96



Used for WM51, WM53, WM56 and WM57 perforated panels to hang accessories or tools;  
Sold in packs of 20.

**Product #**      **Depth**  
WM96-150          1 1/2"

## Double Back Single and Double Hooks

WM98 / WM99



Used for WM51, WM53, WM56 and WM57 perforated panels to hang accessories or tools;  
Sold in packs of 10.

| Product # | Depth | Type   |
|-----------|-------|--------|
| WM98-03   | 3"    | Single |
| WM98-05   | 5"    | Single |
| WM99-03   | 3"    | Double |
| WM99-05   | 5"    | Double |

## Screwdriver Holder

WM95



Used for WM51, WM53, WM56 and WM57 perforated panels to hang screwdrivers;  
May store up to 6 screwdrivers.

**Product #**      **W x D x H**  
WM95-01          9" x 1 1/2" x 1 3/4"

## Single Loop Hooks

WM97



Used for WM51, WM53, WM56 and WM57 perforated panels to hang accessories or tools;  
Sold in packs of 20.

**Product #**      **Diameter**  
WM97-150          1 1/2"  
WM97-200          2"

**NOTE**      Compatible with perforated panels with 1/4" holes at every 1" c/c. These panels are among the most popular on the market.

# Components – Structure Above the Work Surface

WORK CENTER

## Tackboard and Marker Panel

**NEW DIMENSION** WM54

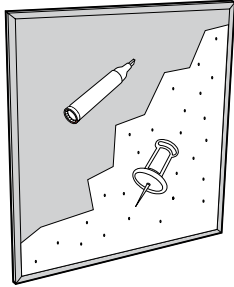

Dual-function reversible panel: tack notes to a cork board and write on a white steel surface using erasable felt-tip markers;

WM50 panel bracket kit must be ordered separately.

| Product # | W x H     | Uprights c/c |
|-----------|-----------|--------------|
| WM54-2424 | 24" x 24" | 28"          |
| WM54-3024 | 30" x 24" | 34"          |

**NEW DIMENSION**

## Louvered Panel for Plastic Bins

WM55

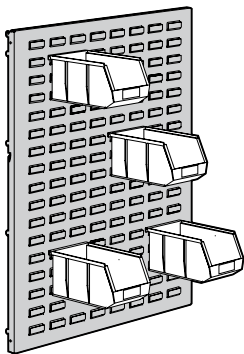

Painted steel;  
Used to hang RG20 plastic bins;  
Can be used for all brands of plastic bins with hanger lip sold on the market;  
Hooks onto WM10 uprights;

Note: 28" W panel must be installed on 28" c/c uprights;

Note: 34" W panel must be installed on 34" c/c uprights;

| Product # | W x H     | Uprights (H) |
|-----------|-----------|--------------|
| WM55-2824 | 28" x 24" | 36" to 48"   |
| WM55-2836 | 28" x 36" | 48"          |
| WM55-3424 | 34" x 24" | 36" to 48"   |
| WM55-3436 | 34" x 36" | 48"          |



## Vertical Adaptor for Electrical and Air Outlets

**PATENTED** WM41

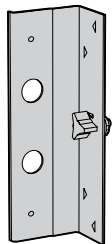

Installs on the side of WM10 upright;  
Can receive a power outlet strip or pneumatic connector.

| Product # | Height | Color |
|-----------|--------|-------|
| WM41-01   | 8"     | Black |

## Panel Bracket Kit

**PATENTED** WM50

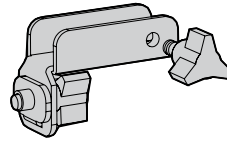

Includes 4 brackets;

Required for installation of WM52, WM53 and WM54 panels;

Easy assembly on WM10 upright sides, no tools required.

| Product # | Color |
|-----------|-------|
| WM50-01   | Black |



## Power Outlet Strip

70000500 / 70000505



15A strip equipped with breakers and 6' extension cord;

Requires WM41 adaptor.

| Product # | Length | No. of outlets            |
|-----------|--------|---------------------------|
| 70000500  | 9"     | 5 without on / off switch |
| 70000505  | 12"    | 6 with on / off switch    |

## Power Outlet Channel

**NEW DIMENSION** WM40

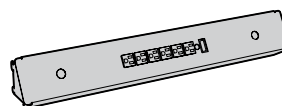

Hooks easily onto WM10 uprights;

Includes 6 outlets (15A or 20A) with interrupter, breaker and 2 knockouts for pneumatic fittings;

Order by adding 01 to the product # for a 15A power strip or 03 for a 20A power strip.

| Product # | Width | Uprights c/c |
|-----------|-------|--------------|
| WM40-28   | 28"   | 28"          |
| WM40-34   | 34"   | 34"          |

**NOTE** If your order the 20A version, ensure that your building has 20A circuits with the special outlets required.

# Components – Structure Above the Work Surface



## Lamp with Magnifier and Fluorescent Light 70000635



Attaches on work surface or on WM10 uprights with a WM68-01 light-duty arm adaptor, sold separately;  
 The lamp's reach on the upright may be lengthened with a WM69-12 light-duty arm, sold separately;  
 Dioptic grade: 3 (magnification: 1.75X);  
 Color: Black;  
 Fluorescent tube included.

**Product #**  
70000635

## Overhead Workstation Light WM45

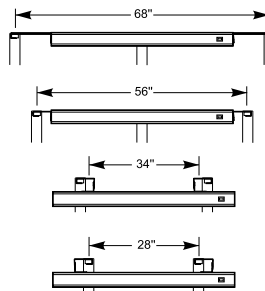
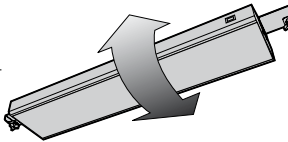

Installs on WM18 cantilever overhead supports (must be ordered separately);  
 2 fluorescent tubes (T8) included;  
 Lighting directed downward; no blinding effects;  
 Installation on single or double unit frames;  
 Attachments allow the light fixture to pivot and adjust front to back;  
 Color: Black;  
 Ballast: electronic;  
 Includes one K12 acrylic louver, 10' extension cord and an on/off switch.

| Product #    | Width |
|--------------|-------|
| WM45-48T8-28 | 28"   |
| WM45-48T8-34 | 34"   |
| WM45-48T8-56 | 56"   |
| WM45-48T8-68 | 68"   |

## Parabolic Louver (1/2" x 1/2") WM46

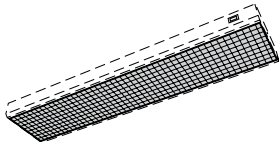

Option for WM45 overhead workstation light to reduce light reflection on a computer screen.

| Product # | Width |
|-----------|-------|
| WM46-4801 | 48"   |



WORK CENTER

## Storage Cabinets

### Storage Cabinet

WM75

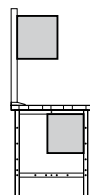
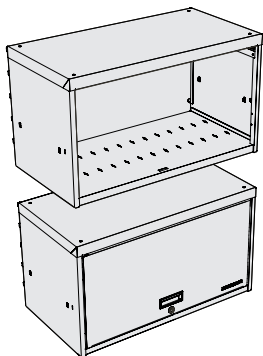

Clips onto WM10 uprights or may be hung under the work surface;  
 May be secured to the uprights with tapping screws;  
 The storage cabinet may be subdivided with a WM20-2812 shelf and SH52-1206 partial dividers, as needed;  
 Capacity: 200 lb;  
 Compatible with LED Light (RD07).

| Product #     | W x D x H   |
|---------------|---|
| WM75-281516   | 28" x 15" x 16"                                   |
| WM75-281516L3 | 28" x 15" x 16"<br>With door and lock<br>(2 keys) |



#### POSSIBLE CONFIGURATIONS



**NOTE** Adjustable shelf (WM20) and dividers (SH52) sold separately.



# Components - Structure Above the Work Surface

WORK CENTER

## Wall Cabinet

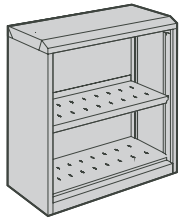

Can be anchored to a wall or installed on a WM11 structure (27", 30" and 36" W) with the RD08 adaptors for WM unit frame;

Bottom shelf included;  
Adjustable shelf included with 30" H cabinet;  
SH52 dividers can be installed on the shelves;  
Wall anchoring not included;  
Choice of doors, complete the part # with:

00: Without doors  
01: Solid integrated door (except the R5MEA-18\_\_)

- 02: Polycarbonate single integrated door (for 24" H housings and over)  
03: Solid double integrated doors (for 24" H housings and over, 30" W and over)  
04: Polycarbonate double integrated doors (for 24" H housings and over, 30" W and over)  
11: Flipper door (for 18" H housings only)

| Height | Width x Depth |            |            |            |
|--------|---------------|------------|------------|------------|
|        | 24" x 14"     | 27" x 14"  | 30" x 14"  | 36" x 14"  |
| 18"    | R5MCA-18__    | R5MPA-18__ | R5MDA-18__ | R5MEA-18__ |
| 24"    | R5MCA-24__    | R5MPA-24__ | R5MDA-24__ | R5MEA-24__ |
| 30"    | R5MCA-30__    | R5MPA-30__ | R5MDA-30__ | R5MEA-30__ |

## Adaptors for RD00 Cabinet

**NEW DIMENSION RD08**

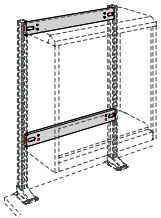

For attaching wall cabinet 27", 30" and 36" W to WM11 unit frame (2 WM10 uprights and WM15 cross member);

Not compatible with the wall cabinet housing RD00 24" W;

Easy to install.

| Product # | Width |
|-----------|-------|
| RD08-28   | 28"   |
| RD08-34   | 34"   |

## Adjustable Shelf

**RD05**

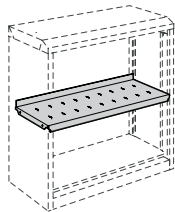

Equipped with back stop to prevent objects from falling into bottom of cabinet;

Adjustable every 1" c/c;  
Can hold up to 100 lb, evenly distributed;  
Compatible with SH52 dividers.

| Product # | W x D     |
|-----------|-----------|
| RD05-2412 | 24" x 12" |
| RD05-2712 | 27" x 12" |
| RD05-3012 | 30" x 12" |
| RD05-3612 | 36" x 12" |

## Lighting Fixture for Wall Cabinet

**RD09**

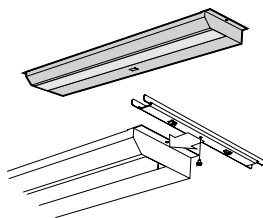

Eliminates shaded areas beneath wall cabinet;  
T8 fluorescent tube included;

Includes acrylic outlet, 10' power cord and switch;

Color: Black;  
Available widths: 36" and 48";  
T8 ballast as energy saver.

| Product # | Color |
|-----------|-------|
| RD09-36T8 | Black |
| RD09-48T8 | Black |

## Wall Cabinet Housing

**RD00**

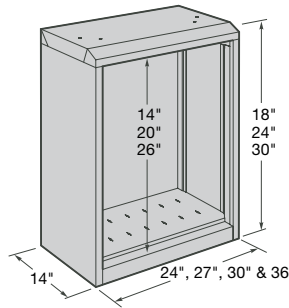

Specifically designed to be anchored to a wall or attached to the WM11 structure (27", 30" and 36" W) with the RD08 adaptors for WM unit frame;

Bottom shelf included;  
Shelves, adjustable every 1" c/c, can be installed;  
Capacity: 600 lbs, wall and wall anchoring must be strong enough;  
Wall anchoring not included;

Cabinet heights available: 18", 24" and 30";  
Adaptors for cabinet RD08 must be ordered to fix the wall cabinet 27", 30" and 36" W attached to the WM11;

Order by adding the cabinet height to the number. Ex: RD00-241418.

| Product #   | W x D     |
|-------------|-----------|
| RD00-2414__ | 24" x 14" |
| RD00-2714__ | 27" x 14" |
| RD00-3014__ | 30" x 14" |
| RD00-3614__ | 36" x 14" |

## Single Integrated Door, Solid and Polycarbonate RD10 / RD11

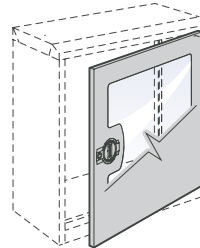

Solid integrated door: RD10;  
Polycarbonate integrated door: RD11;  
Compatible with RD05 adjustable shelves;  
Opens 180° to allow full access to stored items;  
Standard lock included;

Door widths available: 24", 27", 30" and 36";  
Order by specifying the door type, as well as the door width. Ex: RD10-2414L3.

| Product #   | Height |            |
|-------------|--------|------------|
| RD10-__14L3 | 14"    | Except 36" |
| RD__-__20L3 | 20"    |            |
| RD__-__26L3 | 26"    |            |



## Double Integrated Doors, Solid and Polycarbonate RD15 / RD16

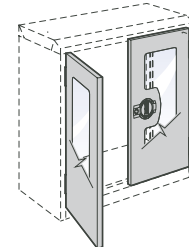

Solid double integrated doors: RD15  
Polycarbonate double integrated doors: RD16  
Compatible with RD05 adjustable shelves;  
Open 180° to allow full access to stored items;  
Standard lock included;

Order by specifying the type of door. Ex.: RD15-3020L3.

| Product #   | W x H     |
|-------------|-----------|
| RD__-3020L3 | 30" x 20" |
| RD__-3026L3 | 30" x 26" |
| RD__-3620L3 | 36" x 20" |
| RD__-3626L3 | 36" x 26" |



## Flipper Door

**RD20**

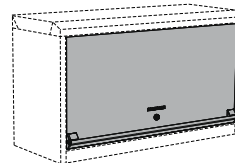

Full width handle for easy, comfortable operation;  
Standard lock included;

To order econo lock-in mechanism, complete part # with B;

Compatible with RD05 adjustable shelves (must be factory installed);

For 18" H cabinet housings only.

| Product #   | W x H     |
|-------------|-----------|
| RD20-2414L3 | 24" x 14" |
| RD20-2714L3 | 27" x 14" |
| RD20-3014L3 | 30" x 14" |
| RD20-3614L3 | 36" x 14" |





# Components – Specialized Structure for Technicians

The specialized structure for technicians allows you to store a multitude of accessories, from the simplest of tools to a computer with LCD monitor, while being very easy to access.

The component layout is easy to change with a minimum number of tools. You can easily change and expand your structure according to your needs. In addition, our products set themselves apart by their superior quality, design and attention to detail. All screws are hidden from view, making the overall look very appealing.



R5XHG-4005

## Tech Upright

## RD44



Used for installing a storage cabinet (RD02), Smart computer cabinet (R5MCA), panel supports (RC47) and power or cover panels (RC60/RC61/RC62/RC63);

Solid anchor system to the top of the work surface.

**Product #**  
RD44-40

## Panel supports

## RC47 Cover Panel

## RC62 / RC63



Used to install finishing panels (RC41/RC42), perforated panels (RC43/RC44) and louvered panels (RC45);

Allows user to install different combinations of panels;

Supports for the lower section 01. Must be ordered when installing two finishing panels, one above the other, or a finishing panel with the RD02 storage cabinet;

Supports for the upper section 02. Must be ordered when installing two finishing panels, one above the other, to create a full-height wall only;

When ordering a support for the lower section add 01 to the end of the number, for the upper section add 02.

| Product # | Width |
|-----------|-------|
| RC47-24   | 24"   |
| RC47-30   | 30"   |
| RC47-36   | 36"   |
| RC47-48   | 48"   |



Painted steel: RC62;

Stainless steel: RC63;

Can be combined with a power feed panel when required, or used on its own to cover the foot of the tech support – used to achieve a polished look;

Height of 4";

Available for application with tech uprights (RD44).

| Product # | Width |
|-----------|-------|
| RC_-2401  | 24"   |
| RC_-3001  | 30"   |
| RC_-3601  | 36"   |
| RC_-4801  | 48"   |

## Power Feed Panel

## RC60 / RC61 Finishing Panel

## RC41 / RC42



Painted steel: RC60;

Stainless steel: RC61;

Can be combined with a cover panel when required, or used on its own to cover the foot of the tech upright – used to achieve a polished look;

Height of 4";

Includes a 6 outlet power bar (15A or 20A), a perforation for air connection and a perforation for a telephone or network jack (covered with a finishing plate);

10' extension cord;

Available for applications with tech uprights (RD44).

| Product # | Width | Amp. |
|-----------|-------|------|
| RC_-3001  | 30"   | 15A  |
| RC_-3003  | 30"   | 20A  |
| RC_-3601  | 36"   | 15A  |
| RC_-3603  | 36"   | 20A  |
| RC_-4801  | 48"   | 15A  |
| RC_-4803  | 48"   | 20A  |

### NOTE

If your order the 20A version, ensure that your building has 20A circuits with the special outlets required.



Painted steel: RC41;

Stainless steel: RC42;

Provides an impeccable finish;

Upper panel can be replaced with a cabinet (RD02);

Stacking two panels (15" + 20") is possible in order to achieve a full height wall;

Lower finishing panel = 15" high;

Upper finishing panel = 20" high;

When ordering a finishing panel for the lower section add 15 to the end of the number, for the upper section add 20.

| Product # | Width |
|-----------|-------|
| RC_-24    | 24"   |
| RC_-30    | 30"   |
| RC_-36    | 36"   |

# Components – Specialized Structure for Technicians

WORK CENTER

## Perforated Panel

RC43 / RC44



Painted steel: RC43;  
Stainless steel: RC44;  
Perforated at every 1" c/c, the panel is compatible with all of the WM9 hooks;  
Upper panel can be replaced with the RD02 cabinet;  
Stacking two panels (15" + 20") is possible in order to achieve a full height wall;  
Lower perforated panel = 15" high;  
Upper perforated panel = 20" high;  
When ordering a perforated panel for the lower section add 15 to the end of the number, for the upper perforated panel add 20.

SEE PAGE 70,123

| Product # | Width |
|-----------|-------|
| RC -24    | 24"   |
| RC -30    | 30"   |
| RC -36    | 36"   |

## Louvered Panel

RC45



Offered in painted steel only;  
Compatible with RG20 plastic bins and any other type of plastic bin with hanging lip on the market;  
Upper panel can be replaced with the RD02 cabinet;  
Stacking two panels (15" + 20") is possible in order to achieve a full height wall;  
Lower louvered panel = 15" high;  
Upper louvered panel = 20" high;  
When ordering a louvered panel for the lower section add 15 to the end of the number, for the upper louvered panel add 20.

| Product # | Width |
|-----------|-------|
| RC45-24   | 24"   |
| RC45-30   | 30"   |
| RC45-36   | 36"   |

## Smart Computer Cabinet



Cabinet dimensions: 24" W x 14" D x 21" H;  
Polycarbonate surface dimensions: 18 7/8" W x 14 1/8" H;  
Useable support surface: 22 1/2" W x 14 1/2" D.

| Product #  | Type  |
|------------|---|
| R5MCA-2450 | Wall-mounted cabinet only   |
| R5MCA-2451 | Wall-mounted cabinet with polycarbonate door                                |
| R5MCA-2452 | Wall-mounted cabinet with keyboard and mouse support                        |
| R5MCA-2453 | Wall-mounted cabinet with polycarbonate door and keyboard and mouse support |
| R5MCA-2454 | Wall-mounted cabinet with flipper door and laptop support                   |

KA, KD or MK  
SEE PAGE 194

## Storage Cabinet

NEW DIMENSION RD02



Can be used in a wall mount application as well as with the RD44 tech uprights;  
The back is detachable for wall mount application which allows for easy access to wall outlets, etc;  
Offers with RD20 flipper door with comfortable full width handle;  
Compatible with the lighting fixture (RD09) and LED light (RD07);  
Standard lock included.

KA, KD or MK  
SEE PAGE 194

| Product #  | W x D x H       |
|------------|-----------------|
| R5MCB-2111 | 24" x 14" x 21" |
| R5MDB-2111 | 30" x 14" x 21" |
| R5MEB-2111 | 36" x 14" x 21" |
| R5MGB-2111 | 48" x 14" x 21" |
| R5MKB-2111 | 60" x 14" x 21" |

## Lighting Fixture

RD09



Eliminates shaded areas beneath upper cabinet;  
T8 fluorescent tube included;  
Includes acrylic outlet, 10' power cord and switch;  
Color: Black;  
Available width: 36" and 48";  
T8 ballast as energy saver.

| Product # | Width |
|-----------|-------|
| RD09-36T8 | 36"   |
| RD09-48T8 | 48"   |

## Adaptor for LED Light

RD06



Using for installing LED light RD07;  
Color: Black;  
Required if the width of the storage cabinet (RD02) is equal to the width of the LED light (RD07);  
To order, choose the product # according to the storage cabinet width (RD02).

| Product # | Storage cabinet width |
|-----------|-----------------------|
| RD06-24   | 24"                   |
| RD06-30   | 30"                   |
| RD06-36   | 36"                   |
| RD06-48   | 48"                   |

## LED Light

RD07



Light equipped with magnet for assembly directly underneath any metal surface;  
Can also be installed under RD02 storage cabinet using RD06 adaptors;  
Each unit is equipped with LED strips;  
Casts brighter light than fluorescent tubes and is energy efficient;  
Equipped with a 60 Watt power supply;  
Equipped with a cord 40" long to plug the supply;  
Adaptor for LED light (RD06) required if the width of the storage cabinet (RD02) is equal to the width of the LED light (RD07);  
The first LED module connected to the power supply controls the light.

| Product # | Lit Surface Area |
|-----------|------------------|
| RD07-024  | 24"              |
| RD07-036  | 36"              |
| RD07-048  | 48"              |
| RD07-060  | 60"              |
| RD07-072  | 72"              |

**NOTE** Not compatible with smart computer cabinet and lighting fixture RD09.

# Accessories - Specialized Structure for Technicians

## Multi-Purpose Support



## RC51 LCD Screen Support



## RC52



Possible to store up to 4 aerosol cans;  
Compatible with pop cans;  
Fastens firmly with hooks to RC41, RC42, RC43, RC44 and RC45 panels;  
Can be installed along the width of the workstation, just above the finishing panel, lower section;  
Model ending with 12 is designed to be installed under the storage cabinet (RD02).

| Product #   | W x D x H      |
|-------------|----------------|
| RC51-120303 | 12" x 3" x 3"  |
| RC51-120312 | 12" x 3" x 12" |



Can be used to hold a screen with anchors on the back spaced at a distance of 75 mm or 100 mm c/c (VESA 75 and 100 standards), to the RC41, RC42, RC43, RC44 and RC45 panels;  
Includes clearance in the centre to manage wiring behind the support;  
2 positions: straight or tilted 10° forward to decrease light reflections.

| Product # |
|-----------|
| RC52-20   |

## Keyboard and Mouse Support



## RC53 Multi-Purpose Support



## RC54



Useable surface 24" W x 12" D for use with a keyboard and a mouse;  
Series of front folds (3/4" surface) for palms of hands;  
Fastens firmly with hooks to RC41, RC42, RC43, RC44 and RC45 panels;  
Can be installed along the width of the workstation, just above the finishing panel, lower section;  
Model ending in 02 designed to be installed under the storage cabinet (RD02).

| Product #   |
|-------------|
| RC53-2412   |
| RC53-241202 |



Can be used to hold different accessories (portable computer, telephone, etc.) measuring 14" W x 12" D at most;  
Includes a clamp to hold documents in place;  
Series of folds at the front (3/4" surface) for palms of hands;  
Fastens firmly with hooks to RC41, RC42, RC43, RC44 and RC45 panels;  
Can be installed along the width of the workstation, just above the finishing panel, lower section;  
Model ending in 02 designed to be installed under the storage cabinet (RD02).

| Product #   |
|-------------|
| RC54-1412   |
| RC54-141202 |



R5XHH-4002



R5XKH-4006



# Components - "5S" Storage



Over the years, Rousseau has developed storage solutions that satisfy the standards of the "5S" methodology. This Japanese technique is intended to continuously improve the work environment. The goal is to improve organization and create a functional work environment while making sure that each tool has its own place and is clearly identified and easy to find. A choice of 18 standard colors is also offered to facilitate your "5S" management by color.

Moreover, the storage solutions we propose enable you to improve your employees' working conditions and morale, while reducing the time and energy they expend.



WORK CENTER

## Wall Panel



**WM57**

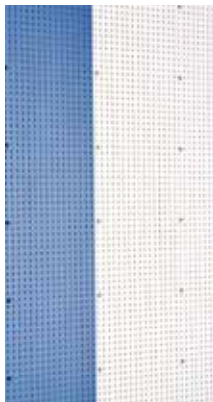

To store small- and medium-sized tools with visual identification close to the worker or in a store;  
 Completely flat surface, which makes visual identification easy, using photos, P-touch, stickers or WM91 adhesive decal;  
 The panels overlap to anchor in the same anchoring zones;  
 The hardware is positioned between two panels, making them very easy to assemble;  
 Vertical installation in keeping with architectural standards, using 16" c/c uprights;  
 Compatible with our heavy-duty hooks;  
 Compatible with our light hooks.

| Product # | W x H     |
|-----------|-----------|
| WM57-1618 | 16" x 18" |
| WM57-1624 | 16" x 24" |
| WM57-1636 | 16" x 36" |
| WM57-1648 | 16" x 48" |
| WM57-1672 | 16" x 72" |

## Finishing Piece



**WM58**



Finishing piece for end of wall panel assembly;  
 Simple and quick to install;  
 Nice appearance;  
 Note: Compatible with wall panel of the same height. Ex.: WM58-36 is only compatible with WM57-1636.

| Product # | Height |
|-----------|--------|
| WM58-18   | 18"    |
| WM58-24   | 24"    |
| WM58-36   | 36"    |
| WM58-48   | 48"    |
| WM58-72   | 72"    |

## Heavy-Duty Hooks

### Heavy-Duty Square Hook



**WM9A**



Used with WM57 wall panels to hang accessories and tools;  
 Flat surface on top;  
 Raised end to prevent accessories or tools from sliding;  
 Hook-on installation;  
 The side security notches ensure stability;  
 Capacity: 50 lb;  
 Sold by the unit;  
 1" wide.

| Product # | Length |
|-----------|--------|
| WM9A-06   | 6"     |
| WM9A-12   | 12"    |

### Heavy-Duty Round Hook



**WM9B**



Used with WM57 wall panels to hang accessories and tools;  
 Tube measures 3/4" in diameter;  
 Allows accessories and tools to slide easily;  
 Hook-on installation;  
 The side security notches ensure stability;  
 Capacity: 50 lb;  
 Sold by the unit;  
 Base of hook: 2" x 3".

| Product # | Length |
|-----------|--------|
| WM9B-06   | 6"     |
| WM9B-12   | 12"    |

## Supports

### Support for Plastic Bin



**WM9C**



Very useful for hanging plastic bins, making it easy to store small parts;  
 Hook-on installation;  
 The side security notches ensure stability;  
 Ideal for plastic bins available on the market that are equipped with a hook-on edge;  
 Compatible with RG20 plastic bins;  
 Bins sold separately.

| Product # | W x H    | Capacity |
|-----------|----------|----------|
| WM9C-06   | 6" x 3"  | 30 lb    |
| WM9C-15   | 15" x 3" | 60 lb    |

### Can Support



**WM9D**



Very useful for storing products of all kinds, such as cans of different sizes;  
 Hook-on installation;  
 The side security notches ensure stability;

| Product # | W x D x H     |
|-----------|---------------|
| WM9D-06   | 6" x 3" x 4"  |
| WM9D-15   | 15" x 3" x 4" |





## Light Hooks



Our family of hooks makes it possible for you to store several types of parts, tools and accessories adequately. Compatible with the panels currently available on the market (1/4" holes), Rousseau perforated panels (WM53, RC43, RC44, SH38, SR39 and SH39) and WM57 wall panels.

| Type/ Package                 | Dimensions                 | Product # | See page   |
|-------------------------------|----------------------------|-----------|------------|
| Multiple tool holder / 1      | 9" W x 1 1/2" H            | WM94-01   | p. 70, 123 |
| Screwdriver holder / 1        | 9" W x 1 1/2" D x 1 3/4" H | WM95-01   | p. 70, 123 |
| Straight hooks / 20           | 1 1/2" D                   | WM96-150  | p. 70, 123 |
| Single hooks / 20             | 1 1/2" diameter            | WM97-150  | p. 70, 123 |
| Single hooks / 20             | 2" diameter                | WM97-200  | p. 70, 123 |
| Double back single hooks / 10 | 3" D                       | WM98-03   | p. 70, 123 |
| Double back single hooks / 10 | 5" D                       | WM98-05   | p. 70, 123 |
| Double back double hooks / 10 | 3" D                       | WM99-03   | p. 70, 123 |
| Double back double hooks / 10 | 5" D                       | WM99-05   | p. 70, 123 |

## "5S" Identification



A wide selection of identification accessories enables you to organize your work space efficiently. Identifying parts, tools and accessories increases your team's efficiency, makes it easier to take inventory, increases productivity and prevents the misplacement or loss of expensive tools. Taking the time to organize things well can save you time and money.

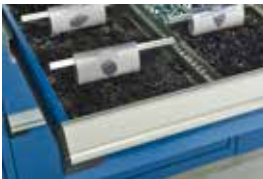

| Accessory                             | Product # | See page   |
|---------------------------------------|-----------|------------|
| Label holder -1" H                    | RG51      | p. 156     |
| Labels for label holder               | RG53      | p. 156     |
| Label holder with adhesive - 1" H     | RG52      | p. 156     |
| Label holder - 1 3/4" H               | RG54      | p. 156     |
| Label holder with adhesive - 1 3/4" H | RG55      | p. 156     |
| Handle protector                      | RF70      | p. 156     |
| Handle labels                         | RF71      | p. 156     |
| Adhesive identification decal         | WM91-01J  | p. 70, 123 |

## Drawer Accessories



A wide variety of drawer accessories, all of which complement one another, facilitates the organization and location of small parts. They are ideal for high-density storage, in addition to keeping space free for growth.

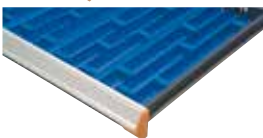

| Accessory                | Product #   | See page        |
|--------------------------|-------------|-----------------|
| Front to back partition  | RG00        | p. 155          |
| Side to side partition   | RG01        | p. 155          |
| Divider                  | RG10        | p. 155          |
| Plastic bins             | RG20        | p. 70, 158, 182 |
| Divider for plastic bins | RG22 / RG24 | p. 158          |
| Groove tray              | RG35        | p. 158          |
| Divider for groove tray  | RG39        | p. 158          |
| Foam for tools           | RG42        | p. 157, 182     |

