

"R" Heavy-Duty Modular Cabinet

"R" CABINET



"R" HEAVY-DUTY MODULAR CABINET



R5AEE-5803

The heavy-duty cabinet, designed for intensive use, present the perfect fit to better respond to our customers needs. It is distinguished by the vast array of dimensions offered, accessories and its perfect modularity, but most of all by its durability.

The Rousseau cabinet comes in 5 different widths, each offered in different depths, for a total of 11 combinations, each available in 6 heights. Add to that the 10 drawer heights, and you have an incredible choice of possibilities. You're guaranteed to find the right size for your specific application.

Tested by an independent laboratory, the Rousseau cabinet proved to be the most durable on the market. The trials proved just how superior our drawer is. This allows us to be 100% confident in offering you a lifetime warranty on the drawer rolling mechanism.

The unique shape of the "R" drawer is a Rousseau Metal Inc. trademark and we own a design patent on the "R" drawer.

The Rousseau cabinet, in addition to being sturdy, offers a refined and unique look, which will stand the test of time. A shining example of unwavering durability.

"R" Heavy-Duty Modular Cabinet

"R" CABINET

The Rousseau Advantages



Sturdy and distinct appearance that works in all sorts of different environments.



10 drawer heights and 7 drawer side heights are available.



True North American dimensions which allow for perfect modularity.



Housings with pre-determined fixing zones for installation of accessories : work surfaces, shelves, etc.



400 lb capacity per drawer. The most heavy-duty in the industry.

General Dimensions

Available Heights

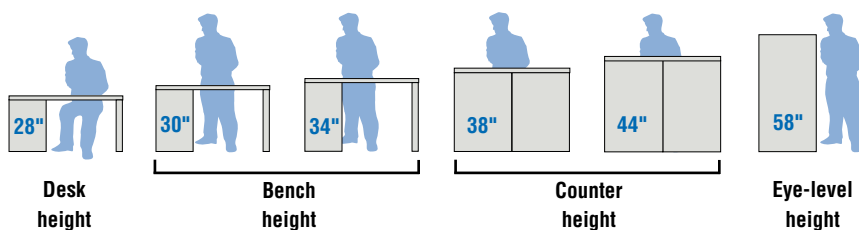

Index	Page(s)
"R" Heavy-Duty Modular Cabinet	4 - 5
Proposals	6 - 9
Accessories	10 - 17
Components	18 - 20
"L" Compact Cabinet	21
Proposals - Cabinets	22 - 23
Proposals - Drawer compartments	24 - 25
Accessories	26 - 29
Components	30 - 31

Width x Depth

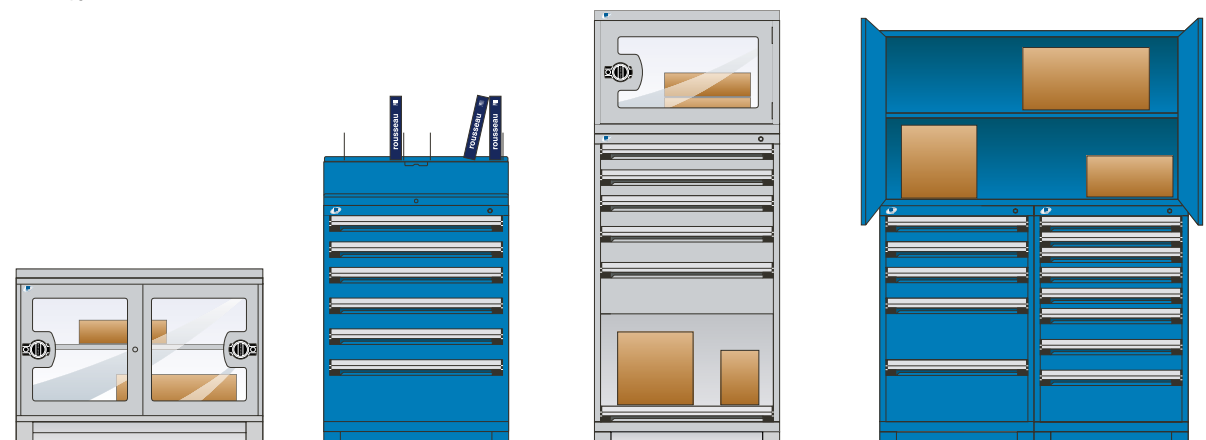
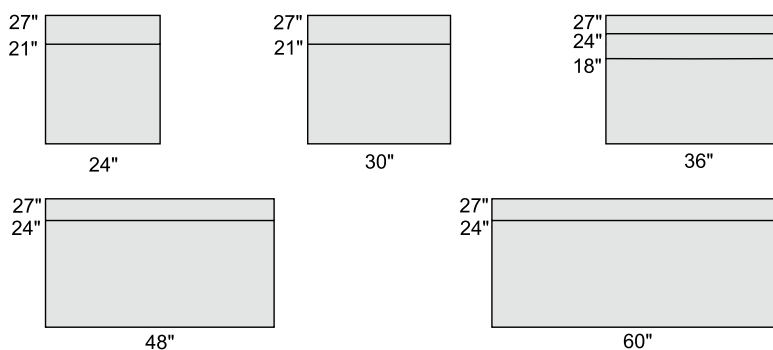

Proposals

"R" CABINET

Shown here are several of the more popular heavy-duty modular cabinet models.

All proposals include a 2" front-access forklift base and a lock on the cabinet housing (for models with more than one drawer) or on the door.

Doors are factory installed with hinges on the right side. They may be installed on the left side, upon request.

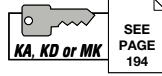

IMPORTANT

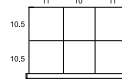

Drawer partitions are included in models.

See number of compartments and proposed layouts on the following page.

NOTE

For drawers without partitioning, complete the even number following the last two digits of the model.

Ex.: R5ACD-2801 with R5ACD-2802 without

24" Wide



6"
6"
6"
6"

4 drawers
R5ACD-2801 24" x 21" x 30"
R5ACG-2801 24" x 27" x 30"



3"
3"
6"
12"

4 drawers
R5ACD-2813 24" x 21" x 30"
R5ACG-2813 24" x 27" x 30"



3"
6"
6"
9"

4 drawers
R5ACD-2805 24" x 21" x 30"
R5ACG-2805 24" x 27" x 30"



3"
3"
4"
4"
4"
8"

6 drawers
R5ACD-3001 24" x 21" x 32"
R5ACG-3001 24" x 27" x 32"



4"
4"
6"
12"

4 drawers
R5ACD-3005 24" x 21" x 32"
R5ACG-3005 24" x 27" x 32"



26"

1 door / 1 adjustable shelf /
1 bottom shelf
R5ACD-3009 24" x 21" x 32"
R5ACG-3009 24" x 27" x 32"



10"
10"
10"

3 drawers
R5ACD-3405 24" x 21" x 36"
R5ACG-3405 24" x 27" x 36"



3"
6"
6"
6"
9"

5 drawers
R5ACD-3403 24" x 21" x 36"
R5ACG-3403 24" x 27" x 36"



3"
3"
3"
3"
4"
4"
4"
4"
6"

9 drawers
R5ACD-3805 24" x 21" x 40"
R5ACG-3805 24" x 27" x 40"



4"
4"
6"
8"
12"

5 drawers
R5ACD-3807 24" x 21" x 40"
R5ACG-3807 24" x 27" x 40"

30" Wide



3"
3"
5"
8"

5 drawers
R5ADD-2801 30" x 21" x 30"
R5ADG-2801 30" x 27" x 30"



4"
4"
8"
8"

4 drawers
R5ADD-2803 30" x 21" x 30"
R5ADG-2803 30" x 27" x 30"



4"
4"
4"
8"
8"

5 drawers
R5ADD-2805 30" x 21" x 30"
R5ADG-2805 30" x 27" x 30"



3"
4"
5"
6"
4"
8"

5 drawers
R5ADD-3003 30" x 21" x 32"
R5ADG-3003 30" x 27" x 32"



3"
3"
5"
5"
5"
5"

6 drawers
R5ADD-3007 30" x 21" x 32"
R5ADG-3007 30" x 27" x 32"



6"
20"

1 drawer / 1 door /
1 bottom shelf
R5ADD-3009 30" x 21" x 32"
R5ADG-3009 30" x 27" x 32"



6"
7"
7"
7"
7"

5 drawers
R5ADD-3815 30" x 21" x 40"
R5ADG-3815 30" x 27" x 40"



3"
3"
3"
3"
5"
5"
10"

7 drawers
R5ADD-3803 30" x 21" x 40"
R5ADG-3803 30" x 27" x 40"



3"
3"
4"
6"
6"
6"
6"
8"

8 drawers
R5ADD-4401 30" x 21" x 46"
R5ADG-4401 30" x 27" x 46"



8"
8"
8"
8"
8"

5 drawers
R5ADD-4411 30" x 21" x 46"
R5ADG-4411 30" x 27" x 46"



Number of Compartments (layout code)										
Drawer dimensions	24" x 21"	24" x 27"	30" x 21"	30" x 27"	36" x 18"	36" x 24"	48" x 24"	48" x 27"	60" x 24"	60" x 27"
3" to 5"	12 (0308)	20 (0316)	24 (0518)	25 (0420)	24 (0518)	30 (0524)	40 (0732)	32 (0724)	70 (1356)	84 (1370)
6" to 8"	9 (0206)	12 (0209)	12 (0308)	12 (0308)	8 (0304)	12 (0308)	15 (0410)	15 (0410)	24 (0716)	21 (0614)
9" and higher	4 (0102)	6 (0104)	6 (0203)	9 (0206)	6 (0203)	9 (0206)	8 (0304)	8 (0304)	12 (0308)	12 (0308)

NOTE For inside drawer dimensions.

SEE PAGES 140-141

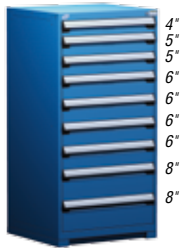

9 drawers
 R5ADD-5805 30" x 21" x 60"
 R5ADG-5805 30" x 27" x 60"

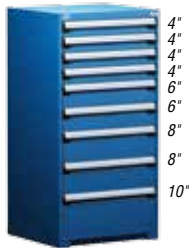

9 drawers
 R5ADD-5809 30" x 21" x 60"
 R5ADG-5809 30" x 27" x 60"



6 drawers
 R5ADD-5843 30" x 21" x 60"
 R5ADG-5843 30" x 27" x 60"



9 drawers
 R5ADD-5813 30" x 21" x 60"
 R5ADG-5813 30" x 27" x 60"



1 door /
 1 bottom shelf / 5 drawers
 R5ADD-5845 30" x 21" x 60"
 R5ADG-5845 30" x 27" x 60"

NEW PROPOSAL

NEW PROPOSAL

36" Wide



4 drawers
 R5AEC-2801 36" x 18" x 30"
 R5AEE-2801 36" x 24" x 30"



4 drawers
 R5AEC-2803 36" x 18" x 30"
 R5AEE-2803 36" x 24" x 30"



5 drawers
 R5AEC-3005 36" x 18" x 32"
 R5AEE-3005 36" x 24" x 32"



2 drawers
 R5AEC-3021 36" x 18" x 32"
 R5AEE-3021 36" x 24" x 32"



5 drawers
 R5AEC-3805 36" x 18" x 40"
 R5AEE-3805 36" x 24" x 40"

NEW PROPOSAL



5 drawers
 R5AEC-3807 36" x 18" x 40"
 R5AEE-3807 36" x 24" x 40"



7 drawers
 R5AEC-4403 36" x 18" x 46"
 R5AEE-4403 36" x 24" x 46"



11 drawers
 R5AEC-4405 36" x 18" x 46"
 R5AEE-4405 36" x 24" x 46"



Double door / 1 adjustable shelf /
 1 bottom shelf
 R5AEC-4412 36" x 18" x 46"
 R5AEE-4412 36" x 24" x 46"



8 drawers
 R5AEC-4415 36" x 18" x 46"
 R5AEE-4415 36" x 24" x 46"

NEW PROPOSAL

Proposals

"R" CABINET



11 drawers
 R5AEC-5803 36" x 18" x 60"
 R5AEE-5803 36" x 24" x 60"



9 drawers
 R5AEC-5813 36" x 18" x 60"
 R5AEE-5813 36" x 24" x 60"



6 drawers
 R5AEC-5859 36" x 18" x 60"
 R5AEE-5859 36" x 24" x 60"



8 drawers
 R5AEC-5825 36" x 18" x 60"
 R5AEE-5825 36" x 24" x 60"



7 drawers
 R5AEC-5861 36" x 18" x 60"
 R5AEE-5861 36" x 24" x 60"

48" Wide



5 drawers
 R5AHE-3003 48" x 24" x 32"
 R5AHG-3003 48" x 27" x 32"



7 drawers
 R5AHE-3801 48" x 24" x 40"
 R5AHG-3801 48" x 27" x 40"



1 sliding door / 1 adjustable shelf /
 1 bottom shelf
 R5AHE-3803 48" x 24" x 40"
 R5AHG-3803 48" x 27" x 40"



5 drawers
 R5AHE-3807 48" x 24" x 40"
 R5AHG-3807 48" x 27" x 40"



9 drawers
 R5AHE-4405 48" x 24" x 46"
 R5AHG-4405 48" x 27" x 46"



7 drawers
 R5AHE-4407 48" x 24" x 46"
 R5AHG-4407 48" x 27" x 46"



Double door / 1 adjustable
 shelf / 1 bottom shelf
 R5AHE-4414 48" x 24" x 46"
 R5AHG-4414 48" x 27" x 46"



5 drawers
 R5AHE-4427 48" x 24" x 46"
 R5AHG-4427 48" x 27" x 46"



15 drawers
 R5AHE-5805 48" x 24" x 60"
 R5AHG-5805 48" x 27" x 60"



6 drawers
 R5AHE-5807 48" x 24" x 60"
 R5AHG-5807 48" x 27" x 60"



8 drawers
 R5AHE-5809 48" x 24" x 60"
 R5AHG-5809 48" x 27" x 60"



9 drawers
 R5AHE-5813 48" x 24" x 60"
 R5AHG-5813 48" x 27" x 60"

60" Wide

NEW PROPOSAL



5 drawers

R5AKE-3805	60" x 24" x 40"
R5AKG-3805	60" x 27" x 40"

NEW PROPOSAL



7 drawers

R5AKE-3807	60" x 24" x 40"
R5AKG-3807	60" x 27" x 40"



6 drawers

R5AKE-4401	60" x 24" x 46"
R5AKG-4401	60" x 27" x 46"



1 sliding door/2 adjustable shelves/1 bottom shelf

R5AKE-4406	60" x 24" x 46"
R5AKG-4406	60" x 27" x 46"



5 drawers/1 roll-out shelf

R5AKE-5801	60" x 24" x 60"
R5AKG-5801	60" x 27" x 60"



9 drawers

R5AKE-5803	60" x 24" x 60"
R5AKG-5803	60" x 27" x 60"



Security Accessories and Recommendations

"R" CABINET

Vertical Security Bar **RB10**



Locks all of the cabinet drawers with one padlock;
Safety hasp is located at the top of the bar to facilitate access;
Available to cover overall drawer heights from 24" to 54";
Complete access to drawers is possible, even when installed against a wall;
Possible to install more than one bar on the same cabinet (for different users);
Installs on the right side.

Product #	Height
RB10-24LPA	24"
RB10-26LPA	26"
RB10-30LPA	30"
RB10-34LPA	34"
RB10-40LPA	40"
RB10-54LPA	54"

Security Panel **RF91**

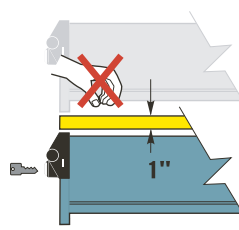

Blocks access between two drawers with locks;
Usable space in cabinet reduced by 1";
Installed between two drawers;
Allows for the cabinet to be divided up for more than one user;
Order by specifying the width and dept.
Ex.: RF91-36 24 for a 36" W x 24" D security panel.

Product #
RF91-__

Cabinet Lock **L3**



Allows user to lock all drawers and roll-out shelves in the cabinet at same time;
Possible to change drawer and roll-out shelf positions;
Easy to retrofit;
Order by adding L3 to the cabinet housing number. Ex.: RA30-302758L3;
For replacement parts or to retrofit this mechanism, order RB00-XXXXL3.

Product #
L3

True One-Drawer-at-a-Time System **PATENTED RB15**

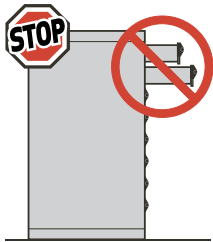

Prevents opening several drawers simultaneously. This ensures cabinet stability and protects the users;

To retrofit this mechanism, order RB15-XX-XX; for factory installation, add A to the cabinet housing number;
SEE PAGE 18
One kit per cabinet.

Product #	Cabinet Height
RB15-28-08	28"
RB15-30-08	30"
RB15-34-10	34"
RB15-38-11	38"
RB15-44-13	44"
RB15-58-18	58"

Recommended for mobile cabinets and cabinets not anchored to the floor.

Cabinet Safety Hasp **LP**



Allows user to lock all drawers and roll-out shelves in the cabinet at the same time;
Possible to change drawer and roll-out shelf positions;
Alternative to the RB10 vertical security bar;
Easy to retrofit;
Order by adding LP to the cabinet housing number. Ex.: RA30-302758LP;
For replacement parts or to retrofit this mechanism, order RB00-XXXXLP.

Product #
LP

Cabinet Tops

Slope Top **RC30**

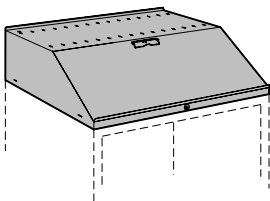

The 30° inclined surface opens to store documents or other items;
Adapted to install a lamp with a 1/2" diameter pivot rod;
Can receive SH52 divider every 2" c/c (except for 18" D);
Capacity : 100 lb (evenly distributed);
For compatibility with doors with frame, choose top that is 3" deeper than your cabinet. Ex.: 27" D cabinet + door with 3" frame = 30" D slope top;
Standard lock included.

Product #	W x D x H	Compatible Divider
RC30-242708L3	24" x 27" x 8"	SH52-1506
RC30-302708L3	30" x 27" x 8"	SH52-1506
RC30-303008L3	30" x 30" x 8"	SH52-1806
RC30-362408L3	36" x 24" x 8"	SH52-1206
RC30-362708L3	36" x 27" x 8"	SH52-1506
RC30-363008L3	36" x 30" x 8"	SH52-1806
RC30-482408L3	48" x 24" x 8"	SH52-1206
RC30-482708L3	48" x 27" x 8"	SH52-1506
RC30-483008L3	48" x 30" x 8"	SH52-1806

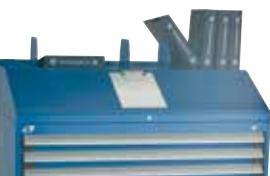

SEE PAGE 194
KA, KD or MK

Partial Divider **PATENTED SH52**

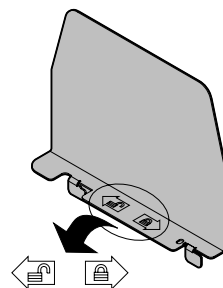

Pictograms to facilitate installation

Innovative patented divider, facilitates easy position changes;
Height : 5 1/2";
Easy installation, without tools.

Product #	Divider Depth
SH52-1206	7 1/8"
SH52-1506	10 1/8"
SH52-1806	13 1/8"

Steel Top with Rubber Mat

RC32



Non-slip rubber surface;
Sides and back formed with a double fold : 1" high.

Laminated Wood Top

WS14



Made from strips of laminated hardwood;
Front 90° rounded edge for added comfort;
Thickness 1 3/4";
Good impact resistance;
Attractive appearance.

Stainless Steel Top



RC35



16 GA stainless steel : RC35-XXXX;
12 GA stainless steel : RC35-XXXX-12;
Serves as a work surface and protects the cabinet against impacts;
Particle board top with stainless steel cover (brushed finish #4);
Excellent corrosion and chemical resistance;
The top respects the CARB regulations on formaldehyde emissions;
Welded corners for attractive look;
Thickness 1 3/4";
To order a top in 12 GA, complete the product number with 12.

Marine Edge Stainless Steel Top



RC35



Marine edge 16 GA stainless steel : RC35-XXXX-16M;
Marine edge 12 GA stainless steel : RC35-XXXX-12M;
Prevents small objects or liquids from falling or spilling from the worksurface;
Serves as a work surface and protects cabinet against impacts;
Composite wood top with stainless steel cover (brushed finish #4);
Excellent corrosion and chemical resistance;
The top respects the CARB regulations on formaldehyde emissions;
Welded corners for attractive look;
Thickness : 1 3/4".
Order by specified the steel gauge. Ex : RC35-XXXX-16M for a marine edge 16 GA stainless steel top.

Painted Steel Top

RC37



Serves as a work surface and protects cabinet against impacts;
Composite wood top with painted steel covers;
The top respects the CARB regulations on formaldehyde emissions;
Welded corners for attractive look;
Thickness 1 3/4";

Galvanized Steel Top

RC36



Serves as a work surface and protects the cabinet against impacts;
Particle board top with galvanized cover;
The top respects the CARB regulations on formaldehyde emissions;
Thickness 1 3/4".

Dimensions		Type of Top					
W	D	Steel Top with Rubber Mat	Laminated Wood Top	Stainless Steel Top	Marine Edge Stainless Steel Top	Galvanized Steel Top	Painted Steel Top
24"	21"	RC32-2421-01					
	27"	RC32-2427-01					
30"	21"	RC32-3021-01					
	24"	RC32-3024-01					
	27"	RC32-3027-01	WS14-3027A*	RC35-3027- **	RC35-3027- M*	RC36-3027	RC37-3027
36"	30"	RC32-3030-01	WS14-3030A*	RC35-3030- **	RC35-3030- M*	RC36-3030	RC37-3030
	18"	RC32-3618-01	WS14-3618A*				RC37-3618
	21"	RC32-3621-01	WS14-3621A*				RC37-3621
	24"	RC32-3624-01	WS14-3624A*	RC35-3624- **	RC35-3624- M*	RC36-3624	RC37-3624
48"	27"	RC32-3627-01	WS14-3627A*	RC35-3627- **	RC35-3627- M*	RC36-3627	RC37-3627
	30"	RC32-3630-01	WS14-3630A*	RC35-3630- **	RC35-3630- M*	RC36-3630	RC37-3630
	24"	RC32-4824-01	WS14-4824A*	RC35-4824- **	RC35-4824- M*	RC36-4824	RC37-4824
60"	27"	RC32-4827-01	WS14-4827A*	RC35-4827- **	RC35-4827- M*	RC36-4827	RC37-4827
	30"	RC32-4830-01	WS14-4830A*	RC35-4830- **	RC35-4830- M*	RC36-4830	RC37-4830
	24"	RC32-6024-01	WS14-6024A*	RC35-6024- **	RC35-6024- M*	RC36-6024	RC37-6024
72"	27"	RC32-6027-01	WS14-6027A*	RC35-6027- **	RC35-6027- M*	RC36-6027	RC37-6027
	30"	RC32-6030-01	WS14-6030A*	RC35-6030- **	RC35-6030- M*	RC36-6030	RC37-6030
	24"	RC32-7224-01	WS14-7224A*	RC35-7224- **	RC35-7224- M*	RC36-7224	RC37-7224
72"	27"	RC32-7227-01	WS14-7227A*	RC35-7227- **	RC35-7227- M*	RC36-7227	RC37-7227
	30"	RC32-7230-01	WS14-7230A*	RC35-7230- **	RC35-7230- M*	RC36-7230	RC37-7230

NOTE * Please check with your customer service representative for lead time. ** 12 GA only.

NOTE

For compatibility with doors with frame, choose top that is 3" deeper than your cabinet.
Ex.: 27" D cabinet + door with 3" frame = 30" D top.

Accessories

"R" CABINET

Back and Side Stop

WS18/WS98

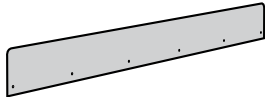

Painted steel : WS18;
 Stainless steel : WS98;
 Can be installed on back or sides according to top dimensions;
 Can be installed on WS14, RC35, RC36, and RC37 tops;
 Height : 5". Clears top by approx. 3/4";
 To order, complete the part # with steel choice needed.

Product #	Length	Product #	Length
WS_-2405	24"	WS_-4205	42"
WS_-2705	27"	WS_-4805	48"
WS_-3005	30"	WS_-6005	60"
WS_-3605	36"	WS_-7205	72"

Power Feed Panel / Cover Panel

Power Feed Panel

RC64/RC65



Painted steel : RC64;
 Stainless steel : RC65;
 Includes a power bar with 6 outlets (15A or 20A), a perforation for air connection and a perforation (covered with a finishing panel) for installation of a telephone jack or computer network;
 Available with or without back finishing panel;
 Can be installed on RC35 and RC37 tops;
 Indicate type of finish when ordering.
 Ex. : RC64-3001 for painted steel.

Cover Panel

RC66/RC67



Painted steel : RC66;
 Stainless steel : RC67;
 Can be combined with a power feed panel on the same workstation or cabinet;
 Available with or without back finishing panel;
 Can be installed on RC35 and RC37 tops;
 Indicate type of finish when ordering.
 Ex.: RC66-3001 for painted steel.

Product #	Amp	Width	With or Without back panel
RC_-3001	15A	30"	without back panel
RC_-3002	15A	30"	with back panel
RC_-3003	20A	30"	without back panel
RC_-3004	20A	30"	with back panel
RC_-3601	15A	36"	without back panel
RC_-3602	15A	36"	with back panel
RC_-3603	20A	36"	without back panel
RC_-3604	20A	36"	with back panel
RC_-4801	15A	48"	without back panel
RC_-4802	15A	48"	with back panel
RC_-4803	20A	48"	without back panel
RC_-4804	20A	48"	with back panel
RC_-6001	15A	60"	without back panel
RC_-6002	15A	60"	with back panel
RC_-6003	20A	60"	without back panel
RC_-6004	20A	60"	with back panel
RC_-7201	15A	72"	without back panel
RC_-7202	15A	72"	with back panel
RC_-7203	20A	72"	without back panel
RC_-7204	20A	72"	with back panel

Product #	Width	With or Without back panel
RC_-2401	24"	without back panel
RC_-2402	24"	with back panel
RC_-3001	30"	without back panel
RC_-3002	30"	with back panel
RC_-3601	36"	without back panel
RC_-3602	36"	with back panel
RC_-4801	48"	without back panel
RC_-4802	48"	with back panel
RC_-6001	60"	without back panel
RC_-6002	60"	with back panel
RC_-7201	72"	without back panel
RC_-7202	72"	with back panel

NOTE If your order the 20A version, ensure that your building has 20A circuits with the special outlets required.



R5XHG-1032

Finishing Panel for Computer Support

RC68/RC69



Painted steel : RC68;
 Stainless steel : RC69;
 Can be installed with a power feed panel or a cover panel;
 Order by indicating the type of finish.
 Ex.: RC68-2401 for painted steel;

Available with or without back finishing panel;
 Equipped with a perforation on the center for installation of RC57/RC58 computer supports.

Product #	Width	With or Without back panel
RC_-2401	24"	without back panel
RC_-2402	24"	with back panel

Computer Supports

Laptop Support

RC58-01



Can be used for a laptop computer or an electronic device etc;
 Usable tray surface 14" W X 12" D;
 Installs on the work surface, with the RC68/RC69 finishing panel for computer support;
 Compatible with the following work surfaces : WS14, RC35, RC36 and RC37;
 The work surface shall extend beyond the rear by 1 1/2";
 Does not install directly on the cabinet;
 Stainless steel upright, 17" H;
 Arm, adaptor and tray in painted steel. Color : black;
 The tray for laptop is adjustable at 13" height to accommodate different users;
 The tray is equipped with non-slip strips (Velcro®) to ensure the laptop doesn't slide.

Product #
 RC58-01

LCD Monitor Support

RC57-01



Can be used to support most LCD monitors available on the market ;
 Installs on the work surface, with the RC68/RC69 finishing panel for computer support;
 Compatible with the following work surfaces : WS14, RC35, RC36 and RC37;
 The work surface shall extend beyond the rear by 1 1/2";
 Does not install directly on the cabinet;
 Stainless steel upright, 17" H;
 Arm and adapter in painted steel. Color: black;
 The LCD monitor support is adjustable at 13" height to accommodate different monitor dimensions and different users;
 Positioning of monitor anchors according to VESA 75 and 100 standards.

Product #
 RC57-01

LCD Monitor, Keyboard and Mouse Support

RC58-02



Installs on the work surface, with the RC68/RC69 finishing panel for computer support;
 Compatible with the following work surfaces : WS14, RC35, RC36 and RC37;
 The work surface shall extend beyond the rear by 1 1/2";
 Does not install directly on the cabinet;
 Stainless steel upright, 17" H;
 Arm, adaptor and tray in painted steel. Color: black;
 The keyboard and mouse tray is adjustable at 13" height to accommodate different users;
 Usable surface of the keyboard and mouse tray : 23 3/8" W x 8 1/2" D;
 The LCD monitor support is adjustable at 13" height to accommodate different monitor dimensions and different users;
 Can support most LCD monitors available on the market;
 Positioning of monitor anchors according to VESA 75 and 100 standards.

Product #
 RC58-02

Double LCD Monitor Support

RC57-03



Can be used to support two LCD monitors ;
 Installs on the work surface, with the RC68/RC69 finishing panel for computer support;
 Compatible with the following work surfaces : WS14, RC35, RC36 and RC37;
 The work surface shall extend beyond the rear by 1 1/2";
 Does not install directly on the cabinet;
 Stainless steel upright, 17" H;
 Arm and adapter in painted steel. Color: black;
 The LCD monitor support is adjustable at 13" height to accommodate different monitor dimensions and different users;
 Positioning of monitor anchors according to VESA 75 and 100 standards.

Product #
 RC57-03

ESD Protection

ESD Cabinet

RC50



Allows for the safe storage of electronic components ;
 Special paint dissipates electric charges ;
 Grounding cord and ground wrist strap socket are included. Cord resistance is 1 M Ω ;
 To order a cabinet equipped with protection against electrostatic discharges ;
 Dissipative paint is Black 090.

Product #
 RC50-01

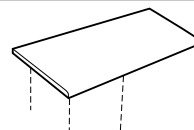
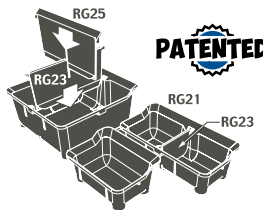
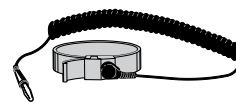

Grounding Wrist Strap

Made of stretch material ;
 Comes with a 6" cord with 1M Ω resistance ;
 Dissipates electric charges that may damage electronic components.

Product #
 70000320

CONDUCTIVE PLASTIC BINS

SEE PAGE 160

DISSIPATIVE TOP

SEE PAGE 100

Stacking Cabinets / Sink Cabinets

Stacking Cabinets

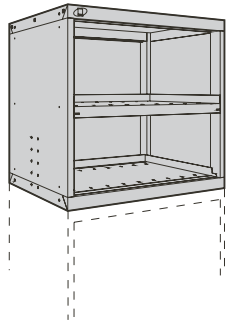

1 shelf, adjustable every 1" c/c;
 1 bottom shelf;
 Standard lock included on doors;
 Choice of doors. Complete the product # by referring to chart below;
 Heights available : 24" and 30";
 Includes hardware kit for stacking;
 To order, complete part # with height wanted and by referring to chart below for door types.
 Ex. : R5HEE-24 03 for a 36" W x 24" D x 24" H cabinet with double integrated doors.

Product #	W x D
R5HDG-___	30" x 27"
R5HEC-___	36" x 18"
R5HEE-___	36" x 24"
R5HEG-___	36" x 27"
R5HHE-___	48" x 24"
R5HHG-___	48" x 27"
R5HKE-___	60" x 24"
R5HKG-___	60" x 27"

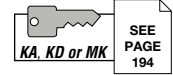

Choice of Doors

Cabinet Widths

	30"	36"	48"	60"
00 Without door	X	X	X	X
01 Single integrated door	X	X		
02 Single integrated polycarbonate door	X	X		
03 Double integrated doors	X	X	X	X
04 Double integrated polycarbonate doors	X	X	X	X
05 Double doors with frame	X	X	X	X
06 Double polycarbonate doors with frame	X	X	X	X
07 Integrated sliding doors			X	X
08 Integrated sliding polycarbonate doors			X	X
09 Sliding doors with frame			X	X
10 Sliding polycarbonate doors with frame			X	X



R5XE-1002

Partial Divider



SH52

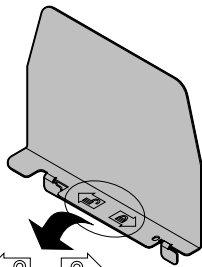

Pictograms to facilitate installation.

Innovative patented divider, facilitates easy position changes;
 Height : 5 1/2";
 Easy installation, without tools.

Product #	Divider Depth	For Shelves
SH52-1506	10 1/8"	18" D
SH52-1806	13 1/8"	21" D
SH52-2106	16 1/8"	24" D
SH52-2406	19 1/8"	27" D



R5XTG-3002

NOTE Sink is not provided by Rousseau

Sink Cabinet

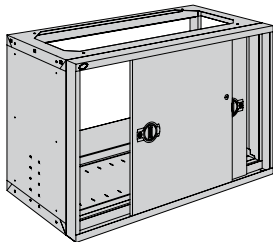

The top has an opening to allow for installation of a sink;
 Has an opening on the back of the housing to allow for installation of a drain and pipes;
 1 bottom shelf;
 Models that have a door with frame are compatible with drawers and roll-out shelves;
 Standard lock included;
 Compatible with bases;
 Heights available : 28", 30" and 34";
 To order, complete the part # with height wanted and by referring to chart below for door types.
 Ex.: R5TDD-28 01.

SEE PAGE 18



Product #	W x D
R5TDD-___*	30" x 21"
R5TDG-___*	30" x 27"
R5THD-___	48" x 21"
R5THG-___	48" x 27"

*Models are not compatible with sliding doors.

01	Single integrated door
02	Double integrated doors
03	Double doors with frame
04	Integrated sliding doors
05	Sliding doors with frame

NOTE Work surfaces must be ordered separately (cut-outs are not provided by Rousseau). Sink not included.

SEE PAGE 100

Stacking Cabinets

Stacking Cabinet Housing

RA30

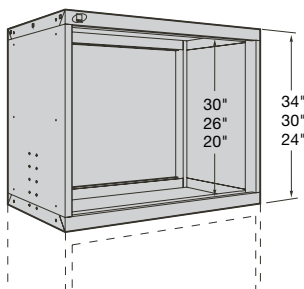

Stacking cabinet housings are designed specifically for stacking on RA30 standard housing units;

Drawers, roll-out shelves, adjustable shelves and bottom shelves can all be installed in these housings;

Compatible with both integrated doors and doors with frame;

Housing heights available : 24", 30" and 34";

Includes hardware kit for stacking;

To order, complete the part # with height wanted. Ex.: RA30-2421₃₀.

Product #	W x D
RA30-2421	24" x 21"
RA30-2427	24" x 27"
RA30-3021	30" x 21"
RA30-3027	30" x 27"
RA30-3618	36" x 18"
RA30-3624	36" x 24"
RA30-3627	36" x 27"

Product #	W x D
RA30-4824	48" x 24"
RA30-4827	48" x 27"
RA30-6024	60" x 24"
RA30-6027	60" x 27"

NOTE Bottom shelf must be ordered separately.

Adjustable Shelf

RB22/RB24

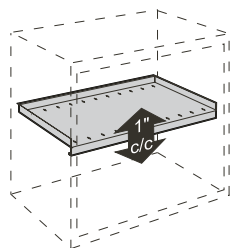

For storing bulky items;

Has edge along the sides and back to prevent items from falling into the bottom of the cabinet;

Adjustable at every 1" c/c;

Up to 400 lb capacity of evenly distributed load;

SH52 dividers can be installed.

Product #	W x D	Capacity*
RB22-2421	24" x 21"	200
RB22-2427	24" x 27"	200
RB24-3021	30" x 21"	400
RB24-3027	30" x 27"	400
RB24-3618	36" x 18"	400
RB24-3624	36" x 24"	400
RB24-3627	36" x 27"	400
RB24-4821	48" x 21"	400
RB24-4824	48" x 24"	400
RB24-4827	48" x 27"	400
RB24-6024	60" x 24"	400
RB24-6027	60" x 27"	400

*in pounds

Bottom Shelf

RB23/RB25

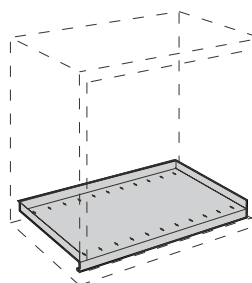

For storing bulky items;

Has edge along the sides and back to prevent items from falling into the bottom of the cabinet;

Up to 400 lb capacity of evenly distributed load;

SH52 dividers can be installed.

Product #	W x D	Capacity*
RB23-2421	24" x 21"	200
RB23-2427	24" x 27"	200
RB25-3021	30" x 21"	400
RB25-3027	30" x 27"	400
RB25-3618	36" x 18"	400
RB25-3624	36" x 24"	400
RB25-3627	36" x 27"	400
RB25-4821	48" x 21"	400
RB25-4824	48" x 24"	400
RB25-4827	48" x 27"	400
RB25-6024	60" x 24"	400
RB25-6027	60" x 27"	400

* in pounds

NOTE For compatibility with double integrated doors or integrated sliding doors, order an adjustable shelf.

NOTE Perforations on top at every 3" c/c for the insertion of partial dividers SH52;

Waste & Recycling Cabinets or Drawer

Waste and Recycling Cabinet

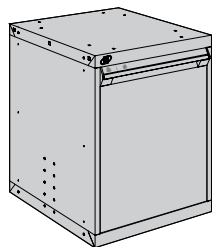

Cabinet can be used as a single unit, integrated in cabinet combinations (ex.: counter cabinets) or integrated underneath the work surface;

Allows sorting objects for recycling;

Equipped with one 26" H drawer with identification on the drawer handle to facilitate sorting;

Equipped with two 15 1/4" W x 11" D x 20" H containers, the black one for waste (RK09-02) and the blue one for recycling (RK09-01);

The drawer has one divider to stabilize the containers and also allows storing objects behind.

Product #	W x D x H
R5XCG-1100	24" x 27" x 30"
R5XDG-1100	30" x 27" x 30"

Waste & Recycling Drawer



Allows sorting objects for recycling;

Identification on the drawer handle to facilitate sorting;

Drawer heights available : 17" and 26";

The 17" H drawer has two containers of 14 3/8" W x 10 1/4" D x 15" H, the black one for waste and the blue one for recycling;

The 26" H drawer has two containers of 15 1/4" W x 11" D x 20" H, the black one for waste and the blue one for recycling;

The drawer has one divider to stabilize the containers and also allows storing objects behind;

To add a locking or security mechanism, complete with product # needed.

Ex. : R51CG-X1701A to add an integrated lock-in mechanism.

Product #	W x D x H
R51CG-X1701	24" x 27" x 17"
R51CG-X2601	24" x 27" x 26"
R51DG-X1701	30" x 27" x 17"
R51DG-X2601	30" x 27" x 26"

Doors

"R" CABINET

Single Integrated Door, Solid or Polycarbonate RB32/RB31

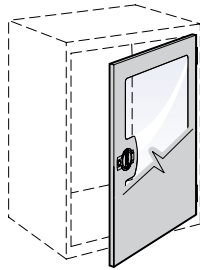

Integrated door : RB32;
 Polycarbonate integrated door : RB31;
 Single door for 24", 30" and 36" wide cabinets;
 Compatible with RB23/RB25 bottom shelf and RB22/RB24 adjustable shelf;
 Opens 180° for full access to items stored inside;
 Factory installed on RA30 cabinet housings;
 Standard lock included;

To receive a safety hasp instead of a standard lock, replace L3 by LP in the product #;

Some door heights may be combined with drawers mounted above or below. In the latter case, you must order a RB22/RB24 adjustable shelf for installation above the section of drawers;

Order by specifying the choice of door.
 Ex.: RB31-3034L3 for a 30" W x 34" H single integrated polycarbonate door;

Note : Not compatible with RF31 drawer or RF40/RF44 roll-out shelf;

Note : Integrated door (RB32) has a finished back for increased rigidity and aesthetics;

Note : Polycarbonate door (RB31) is impact resistant.



Product #	W x H
RB_-2420L3	24" x 20"
RB_-2424L3	24" x 24"
RB_-2426L3	24" x 26"
RB_-2430L3	24" x 30"
RB_-2434L3	24" x 34"
RB_-3020L3	30" x 20"
RB_-3024L3	30" x 24"
RB_-3026L3	30" x 26"
RB_-3030L3	30" x 30"

Product #	W x H
RB_-3034L3	30" x 34"
RB_-3040L3	30" x 40"
RB_-3054L3	30" x 54"
RB_-3620L3	36" x 20"
RB_-3624L3	36" x 24"
RB_-3626L3	36" x 26"
RB_-3630L3	36" x 30"
RB_-3634L3	36" x 34"
RB_-3640L3	36" x 40"
RB_-3654L3	36" x 54"

Double Integrated Doors, Solid or Polycarbonate RB37/RB36

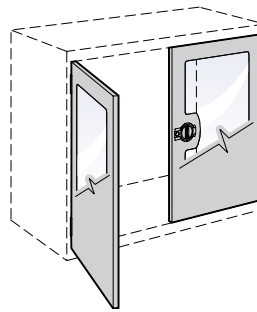

Integrated doors : RB37;
 Polycarbonate integrated doors : RB36;
 Double doors for 30", 36", 48" and 60" wide cabinets;
 Compatible with RB24 adjustable shelf;
 Open 180° for full access to items stored inside;
 Factory installed on RA30 cabinet housings;
 Standard lock included;

To receive a safety hasp instead of a standard lock, replace L3 by LP in the product #;

Some door heights may be combined with drawers mounted above or below. In the latter case, you must order a RB24 adjustable shelf for installation above the section of drawers or a crossbar (RB70) for drawers mounted above;

Order by specifying the choice of door.
 Ex.: RB36-4820L3 for 48" W x 20" H double integrated Polycarbonate doors;

Note : Not compatible with RF31 drawer or RF40/RF44 roll-out shelf;

Note : Not compatible with RB25 bottom shelf;

Note: Integrated door (RB37) has a finished back for increased rigidity and aesthetics;

Note: Polycarbonate doors (RB36) are impact resistant.

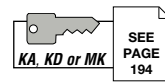

Product #	W x H
RB_-3020L3	30" x 20"
RB_-3024L3	30" x 24"
RB_-3026L3	30" x 26"
RB_-3030L3	30" x 30"
RB_-3034L3	30" x 34"
RB_-3040L3	30" x 40"
RB_-3054L3	30" x 54"
RB_-3620L3	36" x 20"
RB_-3624L3	36" x 24"
RB_-3626L3	36" x 26"
RB_-3630L3	36" x 30"
RB_-3634L3	36" x 34"
RB_-3640L3	36" x 40"
RB_-3654L3	36" x 54"

Product #	W x H
RB_-4820L3	48" x 20"
RB_-4824L3	48" x 24"
RB_-4826L3	48" x 26"
RB_-4830L3	48" x 30"
RB_-4834L3	48" x 34"
RB_-4840L3	48" x 40"
RB_-4854L3	48" x 54"
RB_-6020L3	60" x 20"
RB_-6024L3	60" x 24"
RB_-6026L3	60" x 26"
RB_-6030L3	60" x 30"
RB_-6034L3	60" x 34"
RB_-6040L3	60" x 40"
RB_-6054L3	60" x 54"



R5AHE-4411

Crossbar for Double Integrated Doors **RB70**

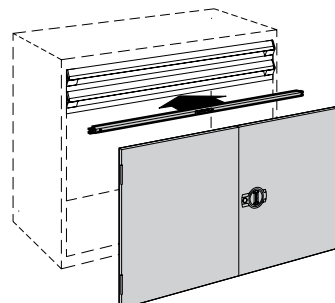

Required for double integrated doors with drawer above.

Product #	Width
RB70-30	30"
RB70-36	36"
RB70-48	48"
RB70-60	60"

Double Doors with Frame, Solid or Polycarbonate

RB45/RB46

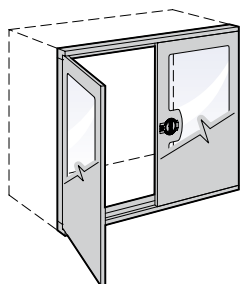

Doors with frame : RB45;
 Polycarbonate doors with frame : RB46;
 Double doors for 30", 36", 48" and 60" wide cabinets;
 Can be installed on cabinets with drawers or roll-out shelves;
 Open 180° for full access to items stored inside;
 Factory installed on RA30 cabinet housings;
 Standard lock included;
 To receive a safety hasp instead of a standard lock, replace L3 by LP in the product #;
 Frame thickness : 3";
 Order by specifying the choice of door.
 Ex. : RB46-4824L3 for 48" W x 24" H double polycarbonate doors with frame;
 Note : Polycarbonate doors (RB46) are impact resistant.



Product #	W x H
RB_-3024L3	30" x 24"
RB_-3028L3	30" x 28"
RB_-3030L3	30" x 30"
RB_-3034L3	30" x 34"
RB_-3038L3	30" x 38"
RB_-3044L3	30" x 44"
RB_-3058L3	30" x 58"
RB_-3624L3	36" x 24"
RB_-3628L3	36" x 28"
RB_-3630L3	36" x 30"
RB_-3634L3	36" x 34"
RB_-3638L3	36" x 38"
RB_-3644L3	36" x 44"
RB_-3658L3	36" x 58"

Product #	W x H
RB_-4824L3	48" x 24"
RB_-4828L3	48" x 28"
RB_-4830L3	48" x 30"
RB_-4834L3	48" x 34"
RB_-4838L3	48" x 38"
RB_-4844L3	48" x 44"
RB_-4858L3	48" x 58"
RB_-6024L3	60" x 24"
RB_-6028L3	60" x 28"
RB_-6030L3	60" x 30"
RB_-6034L3	60" x 34"
RB_-6038L3	60" x 38"
RB_-6044L3	60" x 44"
RB_-6058L3	60" x 58"



R5XKG-1001

Integrated Sliding Doors, Solid or Polycarbonate

RB50/RB51

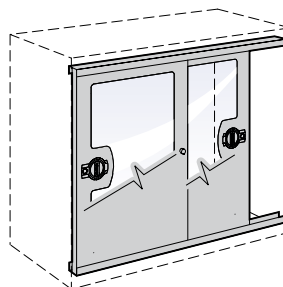

Sliding doors : RB50;
 Sliding polycarbonate doors : RB51;
 Doors for single cabinets 48" and 60" wide;
 Compatible with RB24 adjustable shelf;
 Maximum opening for access to items stored inside;
 Factory installed on RA30 housings;
 Standard lock included;
 Order by specifying the choice of door.
 Ex.: RB51-6020L3 for 60" W x 20" H integrated sliding polycarbonate doors;
 Note : Not compatible with RF31 drawer or RF40/RF44 roll-out shelf;
 Note : Not compatible with RB25 bottom shelf;
 Note : Polycarbonate doors (RB51) are impact resistant.

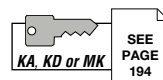

Product #	W x H
RB_-4820L3	48" x 20"
RB_-4824L3	48" x 24"
RB_-4826L3	48" x 26"
RB_-4830L3	48" x 30"
RB_-4834L3	48" x 34"
RB_-4840L3	48" x 40"
RB_-4854L3	48" x 54"

Product #	W x H
RB_-6020L3	60" x 20"
RB_-6024L3	60" x 24"
RB_-6026L3	60" x 26"
RB_-6030L3	60" x 30"
RB_-6034L3	60" x 34"
RB_-6040L3	60" x 40"
RB_-6054L3	60" x 54"

Sliding Doors with Frame, Solid or Polycarbonate

RB55/RB56

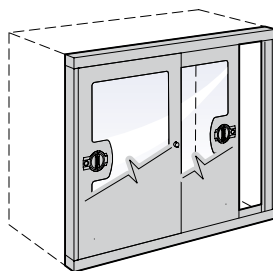

Sliding doors with frame : RB55;
 Sliding polycarbonate doors with frame : RB56;
 Sliding doors for double cabinets (2 x 24" or 2 x 30");
 Compatible with double cabinets (2 x 24" or 2 x 30") with drawers or roll-out shelves;
 Maximum opening for access to items stored inside;
 Factory installed on RA30 cabinet housings;
 Standard lock included;
 Frame thickness : 3";
 Order by specifying the choice of door.
 Ex. : RB56-6024L3 for 60" W x 24" H sliding polycarbonate door with frame;
 Note : Not compatible with 48" and 60" wide single cabinets;
 Note : Polycarbonate doors (RB56) are impact resistant.

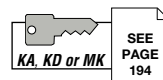

Product #	W x H
RB_-4824L3	48" x 24"
RB_-4828L3	48" x 28"
RB_-4830L3	48" x 30"
RB_-4834L3	48" x 34"
RB_-4838L3	48" x 38"
RB_-4844L3	48" x 44"
RB_-4858L3	48" x 58"

Product #	W x H
RB_-6024L3	60" x 24"
RB_-6028L3	60" x 28"
RB_-6030L3	60" x 30"
RB_-6034L3	60" x 34"
RB_-6038L3	60" x 38"
RB_-6044L3	60" x 44"
RB_-6058L3	60" x 58"

Housings

"R" CABINET

"R" Heavy-Duty Cabinet Housing

RA30

Choose from a wide range of housing unit sizes to customize your storage or work space areas.

Modular drawers, roll-out shelves, adjustable and bottom shelves can be installed;

Compatible with integrated doors and doors with frame;

Housing units are equipped with knock-outs :

- on the top to stack cabinets and install accessories or work surfaces
- on the sides and back to anchor cabinets side-by-side and back-to-back as well as for attaching accessories

Includes anchoring kit for concrete floor, for both cabinet housings and bases, and hardware for stacking;

Cabinet lock allows user to lock all drawers and roll-out shelves in the cabinet at the same time.

Complete product number with L3;

For a safety hasp, complete the product number with LP;

To order a true one-drawer-at-a-time mechanism, complete the product number with A.

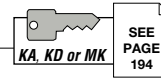

R5AEE-5803

24" and 30" Wide

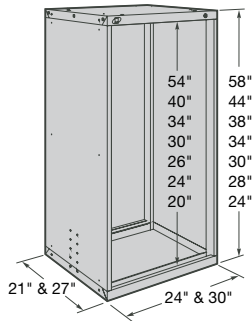

36" Wide

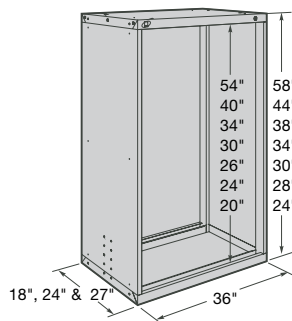

48" and 60" Wide

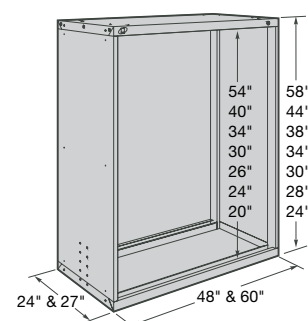

Product #	Total Height	Inside Height
24" x 21"		
RA30-242124	24"	20"
RA30-242128	28"	24"
RA30-242130	30"	26"
RA30-242134	34"	30"
RA30-242138	38"	34"

Product #	Total Height	Inside Height
24" x 27"		
RA30-242724	24"	20"
RA30-242728	28"	24"
RA30-242730	30"	26"
RA30-242734	34"	30"
RA30-242738	38"	34"

Product #	Total Height	Inside Height
30" x 21"		
RA30-302124	24"	20"
RA30-302128	28"	24"
RA30-302130	30"	26"
RA30-302134	34"	30"
RA30-302138	38"	34"
RA30-302144	44"	40"
RA30-302158	58"	54"

Product #	Total Height	Inside Height
30" x 27"		
RA30-302724	24"	20"
RA30-302728	28"	24"
RA30-302730	30"	26"
RA30-302734	34"	30"
RA30-302738	38"	34"
RA30-302744	44"	40"
RA30-302758	58"	54"

Product #	Total Height	Inside Height
36" x 18"		
RA30-361824	24"	20"
RA30-361828	28"	24"
RA30-361830	30"	26"
RA30-361834	34"	30"
RA30-361838	38"	34"
RA30-361844	44"	40"
RA30-361858	58"	54"

Product #	Total Height	Inside Height
36" x 24"		
RA30-362424	24"	20"
RA30-362428	28"	24"
RA30-362430	30"	26"
RA30-362434	34"	30"
RA30-362438	38"	34"
RA30-362444	44"	40"
RA30-362458	58"	54"

Product #	Total Height	Inside Height
36" x 27"		
RA30-362724	24"	20"
RA30-362728	28"	24"
RA30-362730	30"	26"
RA30-362734	34"	30"
RA30-362738	38"	34"
RA30-362744	44"	40"
RA30-362758	58"	54"

Product #	Total Height	Inside Height
48" x 24"		
RA30-482424	24"	20"
RA30-482428	28"	24"
RA30-482430	30"	26"
RA30-482434	34"	30"
RA30-482438	38"	34"
RA30-482444	44"	40"
RA30-482458	58"	54"

Product #	Total Height	Inside Height
48" x 27"		
RA30-482724	24"	20"
RA30-482728	28"	24"
RA30-482730	30"	26"
RA30-482734	34"	30"
RA30-482738	38"	34"
RA30-482744	44"	40"
RA30-482758	58"	54"

Product #	Total Height	Inside Height
60" x 24"		
RA30-602424	24"	20"
RA30-602428	28"	24"
RA30-602430	30"	26"
RA30-602434	34"	30"
RA30-602438	38"	34"
RA30-602444	44"	40"
RA30-602458	58"	54"

Product #	Total Height	Inside Height
60" x 27"		
RA30-602724	24"	20"
RA30-602728	28"	24"
RA30-602730	30"	26"
RA30-602734	34"	30"
RA30-602738	38"	34"
RA30-602744	44"	40"
RA30-602758	58"	54"



Bases

Front Access Forklift Base

RA52

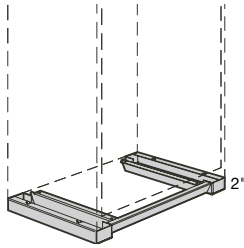

2" high base designed for moving the cabinet from the front with a forklift;

Front cover plate included;

Includes a recessed kick-plate in the center of the cabinet to allow user to stand closer to cabinet;

Designed to enable user to anchor cabinet to the floor;

Compatible with RA74 leveling glides;

Compatible with the RA54 rear base cover plate, offered as an option;

Note : Not compatible with casters;

Note : Not designed for stacking applications.

Product #	W x D
RA52-242102	24" x 21"
RA52-242702	24" x 27"
RA52-302102	30" x 21"
RA52-302702	30" x 27"
RA52-361802	36" x 18"
RA52-362402	36" x 24"
RA52-362702	36" x 27"

Product #	W x D
RA52-482402	48" x 24"
RA52-482702	48" x 27"
RA52-602402	60" x 24"
RA52-602702	60" x 27"

Leveling Glide Kit

RA74

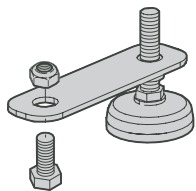

Sold in kits of 4;

Serves to adjust the height of cabinet housings 1 1/2" to 2" on uneven floor surfaces.

Product #

RA74-01

Recessed Base

RA55/RA57

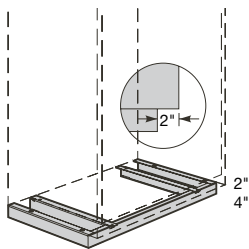

Painted steel RA55;

Stainless steel RA57;

Designed to raise the height of a cabinet by 2" or 4";

Includes a removable cover plate at the front for aesthetics;

Front cover plate is on a straight angle to facilitate cleaning floors;

2" recessed space to allow user to stand closer to cabinet;

Designed to allow user to anchor the cabinet to the floor;

Compatible with RA74 leveling glides;

Compatible with the RA56/RA58 rear base cover plate, offered as an option;

Note : Not compatible with casters;

Note : Not designed for stacking applications;

Order by indicating the type of steel finish. Ex.: RA57-302702 for a stainless steel base 30" W x 27" D x 2" H.

Product #	W x D x H
RA_-242102	24" x 21" x 2"
RA_-242104	24" x 21" x 4"
RA_-242702	24" x 27" x 2"
RA_-242704	24" x 27" x 4"
RA_-302102	30" x 21" x 2"
RA_-302104	30" x 21" x 4"
RA_-302702	30" x 27" x 2"
RA_-302704	30" x 27" x 4"
RA_-361802	36" x 18" x 2"
RA_-361804	36" x 18" x 4"
RA_-362402	36" x 24" x 2"

Product #	W x D x H
RA_-362404	36" x 24" x 4"
RA_-362702	36" x 27" x 2"
RA_-362704	36" x 27" x 4"
RA_-482402	48" x 24" x 2"
RA_-482404	48" x 24" x 4"
RA_-482702	48" x 27" x 2"
RA_-482704	48" x 27" x 4"
RA_-602402	60" x 24" x 2"
RA_-602404	60" x 24" x 4"
RA_-602702	60" x 27" x 2"
RA_-602704	60" x 27" x 4"

Front and Side Access Forklift Base

RA53

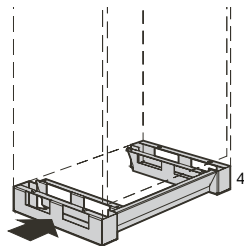

4" high base designed for moving the cabinet from the front or side with a forklift, or from the front with a pallet-jack;

Front cover plate included;

Includes a recessed kick-plate in the center of the cabinet to allow user to stand closer to cabinet;

Designed to enable user to anchor cabinet to the floor;

Compatible with RA74 leveling glides;

Compatible with the RA54 rear base cover plate, offered as an option;

Note : Not compatible with casters;

Note : Not designed for stacking applications.

Product #	W x D
RA53-242104	24" x 21"
RA53-242704	24" x 27"
RA53-302104	30" x 21"
RA53-302704	30" x 27"
RA53-361804	36" x 18"
RA53-362404	36" x 24"
RA53-362704	36" x 27"

Product #	W x D
RA53-482404	48" x 24"
RA53-482704	48" x 27"
RA53-602404	60" x 24"
RA53-602704	60" x 27"

Angled Cover Plate

RA54

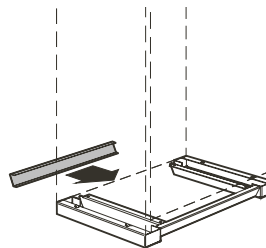

Closes off the back of 2" and 4" forklift bases (RA52 and RA53).

Product #	W x H
RA54-2402	24" x 2"
RA54-2404	24" x 4"
RA54-3002	30" x 2"
RA54-3004	30" x 4"
RA54-3602	36" x 2"
RA54-3604	36" x 4"
RA54-4802	48" x 2"
RA54-4804	48" x 4"
RA54-6002	60" x 2"
RA54-6004	60" x 4"

Straight Cover Plate

RA56/RA58

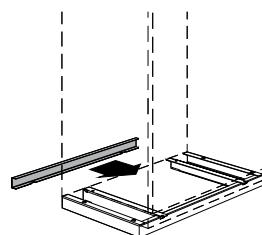

Painted steel RA56;

Stainless steel RA58;

Closes off the back of 2" and 4" recessed bases (RA55 or RA57);

Order by indicating the type of steel finish. Ex.: RA58-4804 for a straight cover plate in stainless steel 48" W x 4" H.

Product #	W x H
RA_-2402	24" x 2"
RA_-2404	24" x 4"
RA_-3002	30" x 2"
RA_-3004	30" x 4"
RA_-3602	36" x 2"
RA_-3604	36" x 4"
RA_-4802	48" x 2"
RA_-4804	48" x 4"
RA_-6002	60" x 2"
RA_-6004	60" x 4"

Drawers, Roll-out Shelves and Locking or Security Mechanisms

"R" CABINET

Heavy-Duty Modular Drawer



RF31 / RF35



Drawer in painted steel : RF31;
 Drawer with stainless steel drawer front : RF35;
 400 lb capacity, 100% extension;
 Heavy-duty construction;
 Easy to install;
 Vast choice of accessories offered to adapt to your storage needs;
 Available drawer heights : 3", 4", 5", 6", 7", 8", 9", 10", 12" and 14";

SEE PAGES 157-161

Order by adding the drawer height to the part # and by specifying the type of drawer front (painted steel or stainless steel). Ex. : RF31-362406;

For modular drawers with layouts,

SEE PAGES 143-156

Product #	W x D
RF_-2421	24" x 21"
RF_-2427	24" x 27"
RF_-3021	30" x 21"
RF_-3027	30" x 27"
RF_-3618	36" x 18"
RF_-3624	36" x 24"
RF_-3627	36" x 27"
RF_-4824	48" x 24"
RF_-4827	48" x 27"
RF_-6024	60" x 24"
RF_-6027	60" x 27"

Heavy-Duty 3-Sided Access Roll-Out Shelf

RF44



400 lb capacity, 100% extension;
 Heavy-duty construction;
 Easy to install;
 Galvanized steel with 1 1/2" edge on back;
 Height : 5";
 May serve as work surface.

Product #	W x D
RF44-2421	24" x 21"
RF44-2427	24" x 27"
RF44-3021	30" x 21"
RF44-3027	30" x 27"
RF44-3618	36" x 18"
RF44-3624	36" x 24"
RF44-3627	36" x 27"
RF44-4824	48" x 24"
RF44-4827	48" x 27"
RF44-6024	60" x 24"
RF44-6027	60" x 27"

Drawer Lock

L3

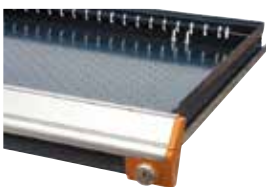

Compatible with all drawer dimensions;
 Does not affect usable drawer space;
 Easy to retrofit;
 Order by adding L3 to drawer or partitioning model number. Ex.: RF31-362406L3;
 For replacement parts or to retrofit this mechanism, order RY01-L3.

KA, KD or MK
 SEE PAGE 194

Product #
 L3

Heavy-Duty Front Access Roll-Out Shelf

RF40



400 lb capacity, 100% extension;
 Heavy-duty construction;
 Easy to install;
 Painted steel with 3" edges on sides and back;
 Height : 6";
 Full access to contents.

Product #	W x D
RF40-2421	24" x 21"
RF40-2427	24" x 27"
RF40-3021	30" x 21"
RF40-3027	30" x 27"
RF40-3618	36" x 18"
RF40-3624	36" x 24"
RF40-3627	36" x 27"
RF40-4824	48" x 24"
RF40-4827	48" x 27"
RF40-6024	60" x 24"
RF40-6027	60" x 27"

Integrated Lock-In Mechanism



A



Activated by tilting the handle up;
 Allows user to open the drawer and the roll-out shelf with one hand only;
 Close by simply pushing it;
 Stops drawer and roll-out shelf from opening on their own;
 Easy to retrofit;
 Order by adding A to the drawer or partitioning, or roll-out shelf model number.
 Ex. : RF31-362406A;
 For replacement parts or to retrofit this mechanism, order RY08-XXA.

Product #
 A

Econo Lock-In Mechanism

B

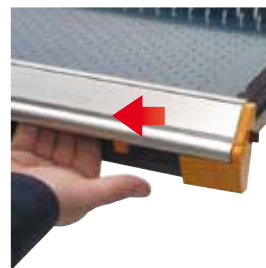

Activated with the right hand by sliding the mechanism with thumb;
 Drawer and roll-out shelf close without having to reactivate the slide mechanism;
 Stops drawer and roll-out shelf from opening on their own;
 Easy to retrofit;
 Order by adding B to the drawer or partitioning, or roll-out shelf model number.
 Ex.: RF31-362406B;
 For replacement parts or to retrofit this mechanism, order RY01-B.

Product #
 B

Lock-Out Mechanism

RF85



For both drawers and roll-out shelves;
 Locks drawers and roll-out shelves in open position;
 Activated manually, only when required;
 Compatible with all accessories drawer;
 Plastic bins positioned in the back row, may make it more difficult to activate mechanism.

Product #
 RF85

