

Spider® Shelving System

SPIDER® SHELVING SYSTEM



SPIDER®
SHELVING SYSTEM

THE MOST VERSATILE SHELVING SYSTEM THAT EXISTS

Much more than a simple shelving unit!

Sturdy construction and quick assembly, the Spider® shelving system meets all of your storage needs. With its vast range of accessories, it offers the most diverse options on the market, making finding solutions for all your storage problems as easy as 1, 2, 3.

- The combination of shelving and Mini-Racking opens up a whole new avenue of possibilities;
- Adding modular drawers guarantees you secure organization of all your small parts;
- Vertical expansion is also a possibility thanks to our multi-level shelving system.

Designed for intensive use, our modular storage system will maximize the space in your warehouse, parts department, maintenance workshop, distribution center, etc.

Our expertise ensures you peace of mind for all of your needs, present and future!



R5XEC-2004

Spider® Shelving System

The Rousseau Advantages



Assembly is simple: shelves are installed on the posts using 4 compression clips, in 14 gauge steel. This makes for easy and fast adjustments.

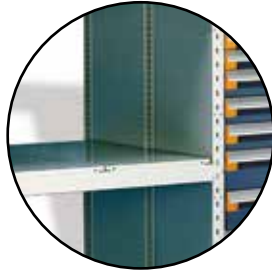

Mini-Racking integrated into your shelving optimizes your storage possibilities.

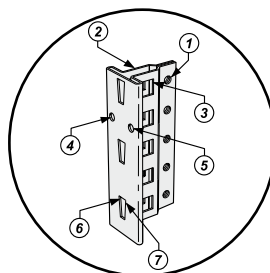

A unique and super functional post. The common post is the cornerstone of the structure. Its unique T-shape offers up to 7 fixing zones for different applications. Plus, its hollow center makes for installations without interference.

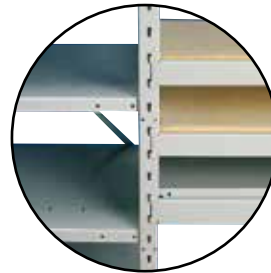

The steel beams are designed for several types of decking: wood, steel and wire. Two types of beams are available, depending on the load capacity and dimensions required. Load capacity can reach 1925 lb.



Each component is designed to offer you an easy-to-use product.

NOTE The unique shape of the Spider® post is a Rousseau Metal Inc. trademark.

General Dimensions

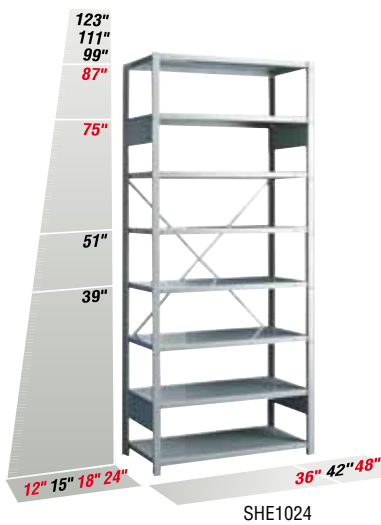

Index	Page(s)
Spider® Shelving System	60 - 61
Industrial Shelving	
Proposals	62 - 66
Accessories	67 - 72
Components	73 - 75
Mini-Racking	
Proposals	76 - 77
Accessories	78
Components	79 - 81

NOTE Popular dimensions shown in red.



R5SSE-874804



R5SSE-874806



SRE9001

Industrial Shelving Proposals

SHELVING



SHE1024



SHE2024

When ordering, model numbers must be completed as follows:

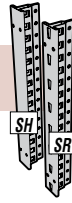

H for posts with smooth finish surface

R for posts with perforated surface

	Starter Unit	Add-on Unit
BOLTED uprights	D	A
WELDED uprights	E	B

EXAMPLE: **S** **D** **1** **0** **0** **1**

1 for open shelving
2 for closed shelving

Example : S H **D** **1** 0 0 1

For a model with smooth finish posts and bolted open uprights

Open and Closed Shelving : 36", 42" and 48" Wide

Open Shelving

Shown here are several of the more popular shelving models.

Proposals include open or closed uprights and BOX shelves;

Closed shelving proposals include back panels and front base;

Open shelving proposals include one back brace.

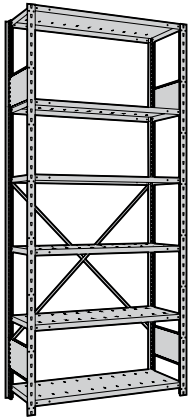

SRE1011
Starter

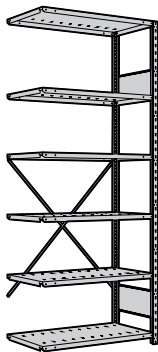

SRB1011
Add-on

Closed Shelving

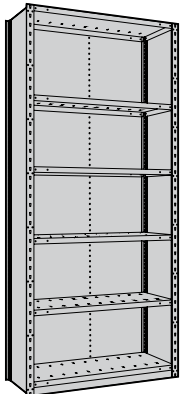

SRE2011
Starter

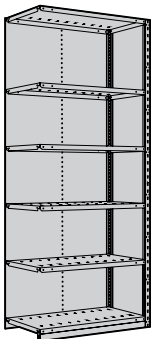

SRB2011
Add-on

W	Dimensions		Number of Shelves				
	D	H	5	6	7	8	
36"	12"	75"	S_001	S_007	S_013	S_019	
		18"	S_002	S_008	S_014	S_020	
		24"	S_003	S_009	S_015	S_021	
	18"	87"	S_004	S_010	S_016	S_022	
		18"	S_005	S_011	S_017	S_023	
		24"	S_006	S_012	S_018	S_024	
	24"	99"	S_401	S_407	S_413	S_419	
		18"	S_402	S_408	S_414	S_420	
		24"	S_403	S_409	S_415	S_421	
	42"	12"	75"	S_131	S_137	S_143	S_149
			18"	S_132	S_138	S_144	S_150
			24"	S_133	S_139	S_145	S_151
18"		87"	S_134	S_140	S_146	S_152	
		18"	S_135	S_141	S_147	S_153	
		24"	S_136	S_142	S_148	S_154	
24"		99"	S_531	S_537	S_543	S_549	
		18"	S_532	S_538	S_544	S_550	
		24"	S_533	S_539	S_545	S_551	
48"		12"	75"	S_031	S_037	S_043	S_049
			18"	S_032	S_038	S_044	S_050
			24"	S_033	S_039	S_045	S_051
	18"	87"	S_034	S_040	S_046	S_052	
		18"	S_035	S_041	S_047	S_053	
		24"	S_036	S_042	S_048	S_054	
	24"	99"	S_431	S_437	S_443	S_449	
		18"	S_432	S_438	S_444	S_450	
		24"	S_433	S_439	S_445	S_451	

Back-to-Back Open and Closed Shelving : 36", 42" and 48" Wide

Open Shelving

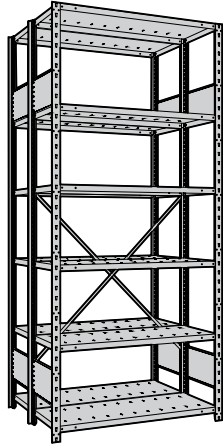

SRE1011B
Starter

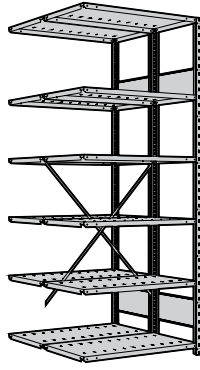

SRB1011B
Add-on

Closed Shelving

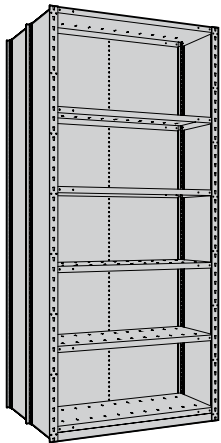

SRE2011B
Starter

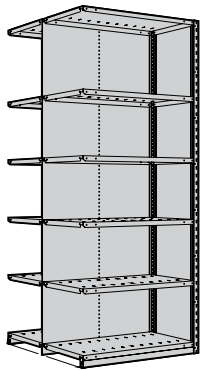

SRB2011B
Add-on

Shown here are several of the more popular shelving models.

Proposals include open or closed uprights and BOX shelves;

Closed shelving proposals include back panels and front base;

Open shelving proposals include one back brace.

Dimensions			Number of Shelves				
W	D	H	10	12	14	16	
36"	24"	75"	S__001B	S__007B	S__013B	S__019B	
			S__002B	S__008B	S__014B	S__020B	
			S__003B	S__009B	S__015B	S__021B	
	24"	87"	S__004B	S__010B	S__016B	S__022B	
			S__005B	S__011B	S__017B	S__023B	
			S__006B	S__012B	S__018B	S__024B	
	24"	99"	S__401B	S__407B	S__413B	S__419B	
			S__402B	S__408B	S__414B	S__420B	
			S__403B	S__409B	S__415B	S__421B	
	42"	24"	75"	S__131B	S__137B	S__143B	S__149B
				S__132B	S__138B	S__144B	S__150B
				S__133B	S__139B	S__145B	S__151B
24"		87"	S__134B	S__140B	S__146B	S__152B	
			S__135B	S__141B	S__147B	S__153B	
			S__136B	S__142B	S__148B	S__154B	
24"		99"	S__531B	S__537B	S__543B	S__549B	
			S__532B	S__538B	S__544B	S__550B	
			S__533B	S__539B	S__545B	S__551B	
48"		24"	75"	S__031B	S__037B	S__043B	S__049B
				S__032B	S__038B	S__044B	S__050B
				S__033B	S__039B	S__045B	S__051B
	24"	87"	S__034B	S__040B	S__046B	S__052B	
			S__035B	S__041B	S__047B	S__053B	
			S__036B	S__042B	S__048B	S__054B	
	24"	99"	S__431B	S__437B	S__443B	S__449B	
			S__432B	S__438B	S__444B	S__450B	
			S__433B	S__439B	S__445B	S__451B	



Industrial Shelving Proposals

87" High Closed Shelving with Accessories

Shown here are several of the most popular shelving models. **NOTE** To complete product #.

SEE PAGE 62

NOTE Front base is always included with closed shelving proposals.

SHELVING

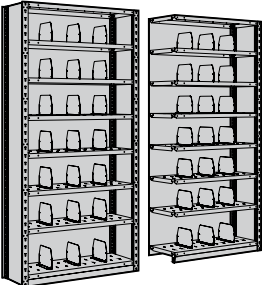

Shelving with Dividers
8 shelves
28 openings :
- 28 op. 12" x 9"
21 dividers, 5 1/2" high

SRE3009 Starter SRB3009 Add-on

Product #	W x D
S_3008	36" x 12"
S_3009	36" x 18"
S_3010	36" x 24"

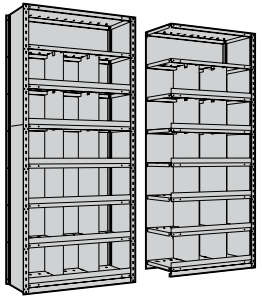

Shelving with Dividers
8 shelves
19 openings :
- 18 op. 12" x 12"
- 1 op. 36" x 12"
12 dividers, 12" high
6 shelf fronts

SRE3022 Starter SRB3022 Add-on

Product #	W x D
S_3021	36" x 12"
S_3022	36" x 18"
S_3023	36" x 24"

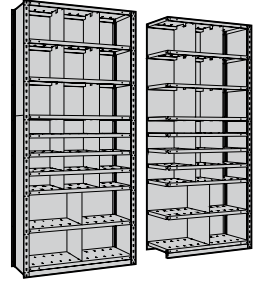

Shelving with Dividers
10 shelves
25 openings :
- 9 op. 12" x 12"
- 12 op. 12" x 6"
- 4 op. 18" x 12"
8 dividers, 6" high
8 dividers, 12" high

SRE3032 Starter SRB3032 Add-on

Product #	W x D
S_3031	36" x 12"
S_3032	36" x 18"
S_3033	36" x 24"

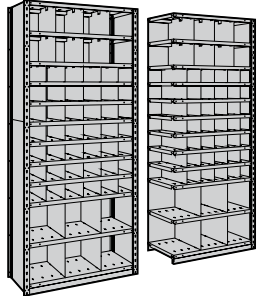

Shelving with Dividers
12 shelves
56 openings :
- 8 op. 9" x 9"
- 42 op. 6" x 6"
- 6 op. 12" x 12"
35 dividers, 6" high
6 dividers, 9" high
4 dividers, 12" high

SRE3052 Starter SRB3052 Add-on

Product #	W x D
S_3051	36" x 12"
S_3052	36" x 18"
S_3053	36" x 24"

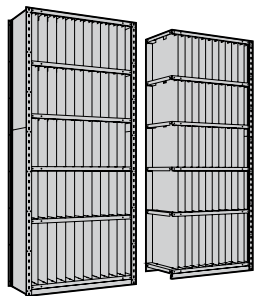

Shelving with Dividers for X-ray Files
6 shelves
60 openings :
- 48 op. 3" x 16"
- 12 op. 3" x 20"
44 dividers, 16" high
11 dividers, 20" high

SRE3062 Starter SRB3062 Add-on

Product #	W x D
S_3062	36" x 18"

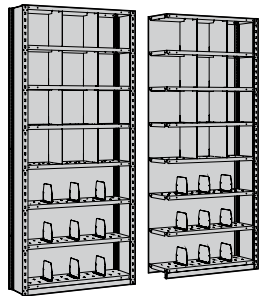

Shelving with Dividers
8 shelves
8 dividers, 12" high
9 dividers, 5 1/2" high

SRE3005 Starter SRB3005 Add-on

Product #	W x D
S_3004	36" x 12"
S_3005	36" x 18"
S_3006	36" x 24"

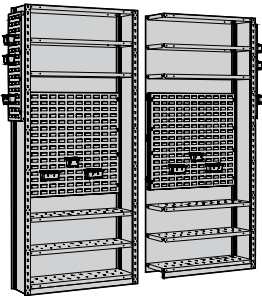

Shelving with Accessories
6 shelves
2 louvered panels
6 plastic bins

SRE3202 Starter SRB3202 Add-on

Product #	W x D
S_3201	36" x 12"
S_3202	36" x 18"
S_3203	36" x 24"

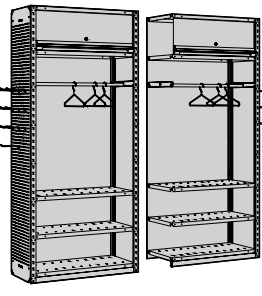

Shelving with Accessories
5 shelves
1 flipper door
1 clothes hanging rail
1 perforated panel
10 hooks

SRE3209 Starter SRB3209 Add-on

Product #	W x D
S_3209	36" x 18"
S_3210	36" x 24"

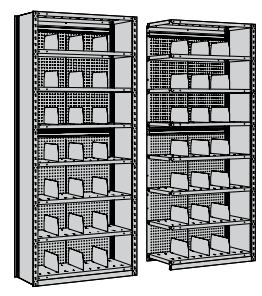

Shelving with Accessories
8 shelves
21 dividers, 5 1/2" high
perforated back panel
10 hooks

SRE3212 Starter SRB3212 Add-on

Product #	W x D
S_3211	36" x 12"
S_3212	36" x 18"
S_3213	36" x 24"

Shown here are some of the most popular drawers in shelving models.
All models include welded closed upright and hook-on mounting brackets for Spider® shelving, allowing for quick and easy assembly;

Additional accessories available : panels (perforated, louvered and finishing panels), shelf dividers, doors, etc.;

To order an add-on unit, complete product number with A.

SEE PAGES 67-72



R5XEE-2001

SHELVING

IMPORTANT

Drawer partitions are included in models.

NOTE

Drawer partitions are included in models.
For drawers without partitioning, complete the even number following the last two digits of the model.
Ex.: R5SEC-751801 with R5SEC-751802 without

Shelving with drawers must be anchored to the floor (anchoring kit included).

Number of Compartments (layout code)						
Drawer dimensions	36" x 18"	36" x 24"	42" x 18"	42" x 24"	48" x 18"	48" x 24"
3" to 5"	24 (0518)	30 (0524)	20 (0512)	30 (0524)	32 (0724)	40 (0732)
6" to 8"	8 (0304)	12 (0308)	12 (0308)	12 (0308)	10 (0405)	15 (0410)
9" and higher	6 (0203)	9 (0206)	6 (0203)	8 (0304)	8 (0304)	8 (0304)

NOTE For inside drawer dimensions.

SEE PAGES 140-141

Shelving with 18", 24", 36" & 48" of Modular Drawers

Shelving with 18" of Modular Drawers



R5SEE-871801

4 drawers :
- 3-4" drawers
- 1-6" drawer

75" H (5 shelves) or 87" H (6 shelves) shelving

W x D	75" H	87" H
36" x 18"	R5SEC-751801_	R5SEC-871801_
36" x 24"	R5SEE-751801_	R5SEE-871801_
42" x 18"	R5SGC-751801_	R5SGC-871801_
42" x 24"	R5SGE-751801_	R5SGE-871801_
48" x 18"	R5SHC-751801_	R5SHC-871801_
48" x 24"	R5SHE-751801_	R5SHE-871801_

Shelving with 24" of Modular Drawers



R5SEE-872401

5 drawers :
- 3-4" drawers
- 2-6" drawers

75" H (5 shelves) or 87" H (6 shelves) shelving

W x D	75" H	87" H
36" x 18"	R5SEC-752401_	R5SEC-872401_
36" x 24"	R5SEE-752401_	R5SEE-872401_
42" x 18"	R5SGC-752401_	R5SGC-872401_
42" x 24"	R5SGE-752401_	R5SGE-872401_
48" x 18"	R5SHC-752401_	R5SHC-872401_
48" x 24"	R5SHE-752401_	R5SHE-872401_

Shelving with 36" of Modular Drawers



R5SEE-873601

7 drawers :
- 3-4" drawers
- 4-6" drawers

75" H (5 shelves) or 87" H (6 shelves) shelving

W x D	75" H	87" H
36" x 18"	R5SEC-753601_	R5SEC-873601_
36" x 24"	R5SEE-753601_	R5SEE-873601_
42" x 18"	R5SGC-753601_	R5SGC-873601_
42" x 24"	R5SGE-753601_	R5SGE-873601_
48" x 18"	R5SHC-753601_	R5SHC-873601_
48" x 24"	R5SHE-753601_	R5SHE-873601_



R5SEE-873603

7 drawers :
- 4-4" drawers
- 2-6" drawers
- 1-8" drawer

75" H (5 shelves) or 87" H (6 shelves) shelving

W x D	75" H	87" H
36" x 18"	R5SEC-753603_	R5SEC-873603_
36" x 24"	R5SEE-753603_	R5SEE-873603_
42" x 18"	R5SGC-753603_	R5SGC-873603_
42" x 24"	R5SGE-753603_	R5SGE-873603_
48" x 18"	R5SHC-753603_	R5SHC-873603_
48" x 24"	R5SHE-753603_	R5SHE-873603_

Industrial Shelving Proposals

SHELVING

Shelving with 48" of Modular Drawers



R5SEE-874801

8 drawers :
- 8-6" drawers
75" H (4 shelves) or 87" H (5 shelves) shelving

W x D	75" H	87" H
36" x 18"	R5SEC-754801_	R5SEC-874801_
36" x 24"	R5SEE-754801_	R5SEE-874801_
42" x 18"	R5SGC-754801_	R5SGC-874801_
42" x 24"	R5SGE-754801_	R5SGE-874801_
48" x 18"	R5SHC-754801_	R5SHC-874801_
48" x 24"	R5SHE-754801_	R5SHE-874801_



R5SEE-874803

9 drawers :
- 4-4" drawers
- 4-6" drawers
- 1-8" drawer
75" H (4 shelves) or 87" H (5 shelves) shelving

W x D	75" H	87" H
36" x 18"	R5SEC-754803_	R5SEC-874803_
36" x 24"	R5SEE-754803_	R5SEE-874803_
42" x 18"	R5SGC-754803_	R5SGC-874803_
42" x 24"	R5SGE-754803_	R5SGE-874803_
48" x 18"	R5SHC-754803_	R5SHC-874803_
48" x 24"	R5SHE-754803_	R5SHE-874803_



R5SEE-874805

10 drawers :
- 6-4" drawers
- 4-6" drawers
75" H (4 shelves) or 87" H (5 shelves) shelving

W x D	75" H	87" H
36" x 18"	R5SEC-754805_	R5SEC-874805_
36" x 24"	R5SEE-754805_	R5SEE-874805_
42" x 18"	R5SGC-754805_	R5SGC-874805_
42" x 24"	R5SGE-754805_	R5SGE-874805_
48" x 18"	R5SHC-754805_	R5SHC-874805_
48" x 24"	R5SHE-754805_	R5SHE-874805_



R5SEE-874807

11 drawers :
- 4-3" drawers
- 3-4" drawers
- 4-6" drawers
75" H (4 shelves) or 87" H (5 shelves) shelving

W x D	75" H	87" H
36" x 18"	R5SEC-754807_	R5SEC-874807_
36" x 24"	R5SEE-754807_	R5SEE-874807_
42" x 18"	R5SGC-754807_	R5SGC-874807_
42" x 24"	R5SGE-754807_	R5SGE-874807_
48" x 18"	R5SHC-754807_	R5SHC-874807_
48" x 24"	R5SHE-754807_	R5SHE-874807_



R5SEE-874809

7 drawers :
- 2-3" drawers
- 3-4" drawers
- 2-6" drawers
1 front access roll-out shelf
75" H (4 shelves) or 87" H (5 shelves) shelving

W x D	75" H	87" H
36" x 18"	R5SEC-754809_	R5SEC-874809_
36" x 24"	R5SEE-754809_	R5SEE-874809_
42" x 18"	R5SGC-754809_	R5SGC-874809_
42" x 24"	R5SGE-754809_	R5SGE-874809_
48" x 18"	R5SHC-754809_	R5SHC-874809_
48" x 24"	R5SHE-754809_	R5SHE-874809_

Dividers

Shelf Divider

SH50

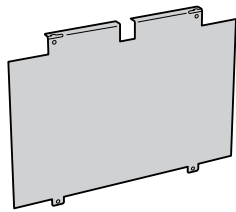

Dividers are attached one into the other;
2 nylon clips provided with each divider;
Nominal dimensions (c/c with shelves);
Offered in painted steel.



Product #	D x H
SH50-1206	12" x 6"
SH50-1209	12" x 9"
SH50-1212	12" x 12"
SH50-1215	12" x 15"
SH50-1218	12" x 18"
SH50-1506	15" x 6"
SH50-1512	15" x 12"
SH50-1806	18" x 6"
SH50-1809	18" x 9"
SH50-1812	18" x 12"
SH50-1815	18" x 15"
SH50-1818	18" x 18"
SH50-1824	18" x 24"

Product #	D x H
SH50-2406	24" x 6"
SH50-2409	24" x 9"
SH50-2412	24" x 12"
SH50-2415	24" x 15"
SH50-2418	24" x 18"
SH50-2424	24" x 24"

Dividers for X-ray Storage

SH50-1816	18" x 16"
SH50-1820	18" x 20"

Other sizes available. Contact your customer service representative for further information.



SHE3062



Partial Divider

PATENTED

SH52

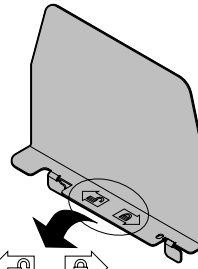

Pictograms make installation easy



Innovative patented divider, facilitates easy position changes;

Height : 5 1/2";

Easy installation, without tools.

Product #	Divider Depth	For Shelves
SH52-1206	7 1/8"	12" D
SH52-1506	10 1/8"	15" D
SH52-1806	13 1/8"	18" D
SH52-2406	19 1/8"	24" D

Dividing Rods

IMPROVED

SH56



Sold in pairs;

Stainless steel rod with 1/4" diameter;

90° fold at one end to ensure it stays in place;

Superior rigidity to plastic rods currently used on the market for this type of application;

Excellent corrosion and chemical resistance.

Product #	Height
SH56-72	72"
SH56-84	84"
SH56-96	96"

Label Holders

Magnetic Label Holder

SH82



Magnetic plastic;
Comes in 6" lengths and can be cut with scissors or a knife;
Note : Paper strips are not included with label holder.

Product #	W x H
SH82-600	6" x 1"

Self-Adhesive Label Holder

SH81



Attaches to surface with self-adhesive strip;

To be used with paper;

Full width;

Note : Paper strips are not included with label holder.

Product #	W x H
SH81-36	36" x 1"
SH81-42	42" x 1"
SH81-48	48" x 1"

Industrial Shelving Accessories

Panels and Doors

SHELVING

Finishing Panel

SH37

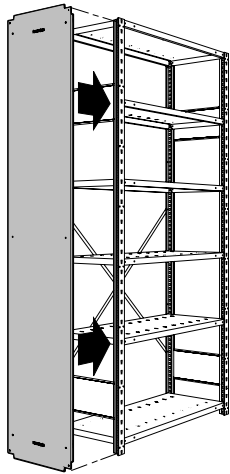

Finishing panel for end of aisle unit;
Fast and easy hook-on assembly;
Polished look;
Compatible with some multi-level shelving applications. Contact our customer service.

Product #	D x H
SH37-12075	12" x 75"
SH37-12087	12" x 87"
SH37-18075	18" x 75"
SH37-18087	18" x 87"
SH37-24075	24" x 75"
SH37-24087	24" x 87"

Perforated Panel

SH38

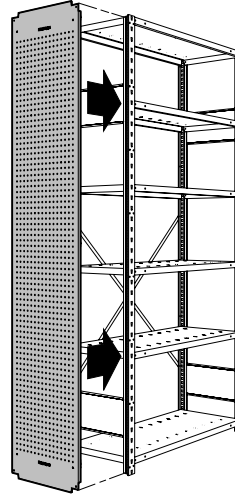

Perforated panel for end of aisle unit;
Holes at every 1 inch c/c;
Compatible with WM94, WM95, WM96, WM97, WM98 and WM99 hooks;
Fast and easy hook-on assembly;
Polished look;
Compatible with some multi-level shelving applications. Contact our customer service.

Product #	D x H
SH38-12075	12" x 75"
SH38-12087	12" x 87"
SH38-18075	18" x 75"
SH38-18087	18" x 87"
SH38-24075	24" x 75"
SH38-24087	24" x 87"

Perforated Back Panel

SR39



Perforated panel for shelving back;
Easy to install;
Compatible with SH31 back panels;
Installs on the back of an existing shelving unit;
Holes at every 1 inch c/c;
Compatible with WM94, WM95, WM96, WM97 and WM99 hooks;

Panel combinations :
- 75" H posts (39" + 39")
- 87" H posts (39" + 51")
- 99" H posts (51" + 51")

Compatible with the upright SR with the perforated surface.

Product #	W x H
SR39-3639	36" x 39"
SR39-3651	36" x 51"
SR39-4239	42" x 39"
SR39-4251	42" x 51"
SR39-4839	48" x 39"
SR39-4851	48" x 51"



Back or Side Louvered Panel

SH65 / SH66



SH65 louvered panel for back of shelving : installs on the inside of the shelving unit, between two shelves;

SH66 louvered panel for side of shelving : installs on either the inside or the outside of the upright;

Simple assembly, no tools required;

Used for hanging RG20 bins;

Compatible with all brands of plastic bins offered on the market that are equipped with a hanging lip.

Back	W x H	Side	D x H
SH65-3621	36" x 21"	SH66-1221	12" x 21"
SH65-3633	36" x 33"	SH66-1233	12" x 33"
SH65-4221	42" x 21"	SH66-1821	18" x 21"
SH65-4233	42" x 33"	SH66-1833	18" x 33"
SH65-4821	48" x 21"	SH66-2421	24" x 21"
SH65-4833	48" x 33"	SH66-2433	24" x 33"

Flipper Door

SH85



Full-width handle;

Standard lock included;

14" high door that will allow you to store folders. Also available : 16" high door which will allow you to store binders;

Installs between 2-SH20 shelves;

SH52 dividers can be installed;

Door heights available : 14", 16", 17" and 18";

Order by adding the door height to the part #.
Ex. : SH85-361816L3.

Product #	Width
SH85-3618_L3	36"
SH85-4218_L3	42"
SH85-4818_L3	48"
SH85-3624_L3	36"
SH85-4224_L3	42"
SH85-4824_L3	48"

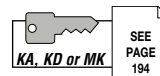

Industrial Shelving Accessories

Doors

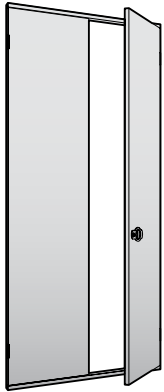

Doors open 180°, with recessed lock and handle;

To receive a safety hasp instead of a standard lock, order SH40-XXXLP instead of SH40-XXXL3;

Simple and fast assembly;

Frame spaced to allow for installation of Rousseau modular drawers;

Compatible with Rousseau Spider® shelving only.

Product #	W x H
SH40-3639L3	36" x 39"
SH40-3675L3	36" x 75"
SH40-3687L3	36" x 87"
SH40-3699L3	36" x 99"
SH40-4239L3	42" x 39"
SH40-4275L3	42" x 75"
SH40-4287L3	42" x 87"
SH40-4299L3	42" x 99"
SH40-4839L3	48" x 39"
SH40-4875L3	48" x 75"
SH40-4887L3	48" x 87"
SH40-4899L3	48" x 99"



SHQ0010

SH40 Polycarbonate Doors



Doors with polycarbonate panels ensure you can see contents;

Excellent impact resistance;

Doors open 180°, with recessed lock and handle;

To receive a safety hasp instead of a standard lock, order SH42-XXXLP instead of SH42-XXXL3;

Simple and fast assembly;

Frame spaced to allow for installation of Rousseau modular drawers;

Compatible with Rousseau Spider® shelving only.

Product #	W x H
SH42-3639L3	36" x 39"
SH42-3675L3	36" x 75"
SH42-3687L3	36" x 87"
SH42-3699L3	36" x 99"
SH42-4239L3	42" x 39"
SH42-4275L3	42" x 75"
SH42-4287L3	42" x 87"
SH42-4299L3	42" x 99"
SH42-4839L3	48" x 39"
SH42-4875L3	48" x 75"
SH42-4887L3	48" x 87"
SH42-4899L3	48" x 99"



SHQ0011 SHQ0012

Miscellaneous Rails

Clothes Hanging Rail

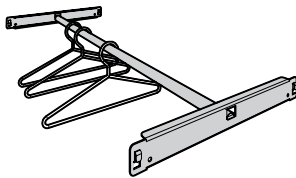

80 lb capacity per rail;

Simple and fast installation;

Installs by hooking to the shelving posts;

Includes one bar with a 1" diameter and 2 adaptors ;

Note : Because of space required under the clothes rail, it is not recommended for use on multi-level shelving installations.

Product #	W x D
SH70-3618	36" x 18"
SH70-3624	36" x 24"
SH70-4218	42" x 18"
SH70-4224	42" x 24"
SH70-4818	48" x 18"
SH70-4824	48" x 24"



SH70 Spool Support

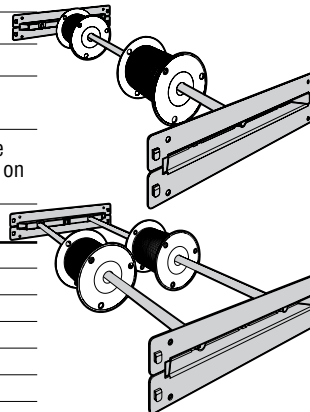

Optimizes storage of spools in shelving;

Offered with one or two rails;

50 lb capacity per rail, 100 lb total per double rail;

Rail(s) with 3/4" diameter, compatible with most spools;

Design allows for pivoting of rail to facilitate changing spools;

Combinations possible for different sized spools.

Product #	W x D	# of Rails
SH72-3612-01	36" x 12"	1 rail
SH72-3618-01	36" x 18"	1 rail
SH72-3618-02	36" x 18"	2 rails
SH72-3624-01	36" x 24"	1 rail
SH72-3624-02	36" x 24"	2 rails
SH72-4212-01	42" x 12"	1 rail
SH72-4218-01	42" x 18"	1 rail
SH72-4218-02	42" x 18"	2 rails
SH72-4224-01	42" x 24"	1 rail
SH72-4224-02	42" x 24"	2 rails
SH72-4812-01	48" x 12"	1 rail
SH72-4818-01	48" x 18"	1 rail
SH72-4818-02	48" x 18"	2 rails
SH72-4824-01	48" x 24"	1 rail
SH72-4824-02	48" x 24"	2 rails

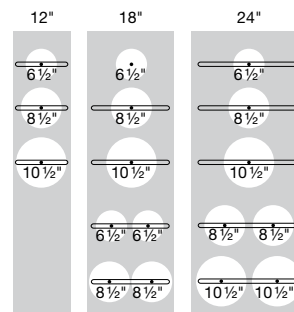

Industrial Shelving Accessories

Vinyl Rub-on Identification Decal

WM91

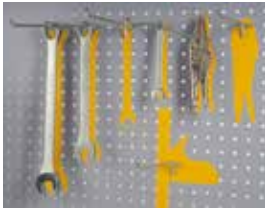

Allows you to easily identify where tools are to be positioned on the perforated panel (SH38, SH39 and SR39);

The contrasting color provides fast retrieval and shows if tools are missing, and which ones;

Efficient help for 5S management;

Sold in rolls 2 feet wide and 8 feet long.

Product #

WM91-01J

Multiple Tool Holder

WM94

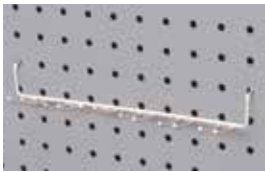

Used for SH38, SR39 and SH39 perforated panels to hang accessories or tools.

Product # W x H

WM94-01 9" x 1 1/2"

Straight Arm Hooks

WM96



Used for SH38, SR39 and SH39 perforated panels to hang accessories or tools;

Sold in packs of 20.

Product # Depth

WM96-150 1 1/2"

Double Back Single and Double Hooks

WM98 / WM99



Used for SH38, SR39 and SH39 perforated panels to hang accessories or tools;

Sold in packs of 10.

Product # Depth Type

WM98-03 3" Single

WM98-05 5" Single

WM99-03 3" Double

WM99-05 5" Double

Screwdriver Holder

WM95



Used for SH38, SR39 and SH39 perforated panels to hang screwdrivers;

May store up to 6 screwdrivers.

Product # W x D x H

WM95-01 9" x 1 1/2" x 1 3/4"

Single Loop Hooks

WM97



Used for SH38, SR39 and SH39 perforated panels to hang accessories or tools;

Sold in packs of 20.

Product # Diameter

WM97-150 1 1/2"

WM97-200 2"

Plastic Bin Rail

SH62

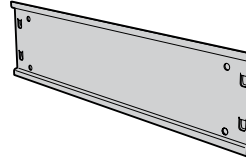

Very useful at ends of aisles. Fast hook-on assembly;

Ideal for all brands of bins from 5" to 7" high;

Bins sold separately.

Product # Depth

SH62-18 18"

SH62-24 24"

Plastic Bin



RG20



Makes storing, moving and inventory of small parts easier. Lightweight and resistant;

Edge at 45° angle for easy identification and easy removal of parts;

Compatible with louvered panels (SH65, SH66) and plastic bin rails (SH62);

6" bins can be partitioned.

Dimensions			Product #		
W	D	H	Bin	Partition	Divider
3"	3"	2"	RG20-030302	-	-
4"	3"	2"	RG20-040302	-	-
6"	3"	2"	RG20-060302	RG22-0302	-
6"	6"	2"	RG20-060602	RG22-0602	RG24-0602
3"	3"	3"	RG20-030303	-	-
4"	3"	3"	RG20-040303	-	-
6"	3"	3"	RG20-060303	RG22-0303	-
6"	6"	3"	RG20-060603	RG22-0603	RG24-0603

NOTE Compatible with perforated panels with 1/4" holes at every 1" c/c. These panels are among the most popular on the market.



SHQ0013

Unit with closed welded upright



SHQ0014

Unit with SH37 finishing panel



SHQ0015

Unit with SH38 perforated panel

Modular Drawers and Roll-out Shelves

Heavy-Duty Modular Drawer



RF32 / RF36



Drawer in painted steel: RF32;
 Drawer with stainless steel drawer front: RF36;
 400 lb capacity, 100% extension;
 Heavy-duty construction;
 Easy to install;
 Vast choice of accessories offered to adapt to your storage needs;
 Available drawer heights : 3", 4", 5", 6", 7", 8", 9", 10", 12" and 14";
 For modular drawers with layouts,

SEE PAGES 157-161

SEE PAGES 143-156

Order by adding the drawer height to the part # and by specifying the type of drawer front (painted steel or stainless steel) Ex. RF32-362406;

Product #	W x D
RF -3618	36" x 18"
RF -3624	36" x 24"
RF -4218	42" x 18"
RF -4224	42" x 24"
RF -4818	48" x 18"
RF -4824	48" x 24"

Heavy-Duty Front Access Roll-Out Shelf

RF41



400 lb capacity, 100% extension;
 Heavy-duty construction;
 Easy to install;
 Painted steel with 3" edges on sides and back;
 Height : 6";
 Full access to contents.

Product #	W x D
RF41-3618	36" x 18"
RF41-3624	36" x 24"
RF41-4218	42" x 18"
RF41-4224	42" x 24"
RF41-4818	48" x 18"
RF41-4824	48" x 24"

Heavy-Duty 3-Sided Access Roll-Out Shelf

RF45



400 lb capacity, 100% extension;
 Heavy-duty construction;
 Easy to install;
 Galvanized steel with 1 1/2" edge on back;
 Height : 5";
 May serve as work surface.

Product #	W x D
RF45-3618	36" x 18"
RF45-3624	36" x 24"
RF45-4218	42" x 18"
RF45-4224	42" x 24"
RF45-4818	48" x 18"
RF45-4824	48" x 24"

Mounting Brackets for Spider® Shelving

RE30

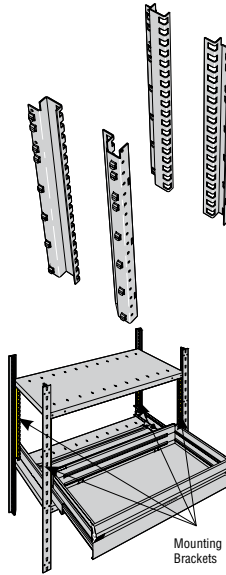

Easy hook-on assembly;
 Standard heights : 18", 24", 30", 34", 36", 46" and 48";
 The mounting bracket kit is compatible with all drawer widths for Rousseau shelving (36", 42" and 48");
 Each kit includes 2 front and 2 rear mounting brackets and all necessary hardware;
 Holes at every 1" c/c for drawer adjustment;
 Two mounting bracket sets may be stacked simply by installing a shelf between them;

SEE PAGE 89

34" high mounting brackets are used with 39" posts or doors;

To order mounting brackets of non-standard heights, contact our customer service representative.

Product #	Height
RE30-18	18"
RE30-24	24"
RE30-30	30"
RE30-34	34"
RE30-36	36"
RE30-46	46"
RE30-48	48"

Shelving units with drawers must be anchored to the ground.

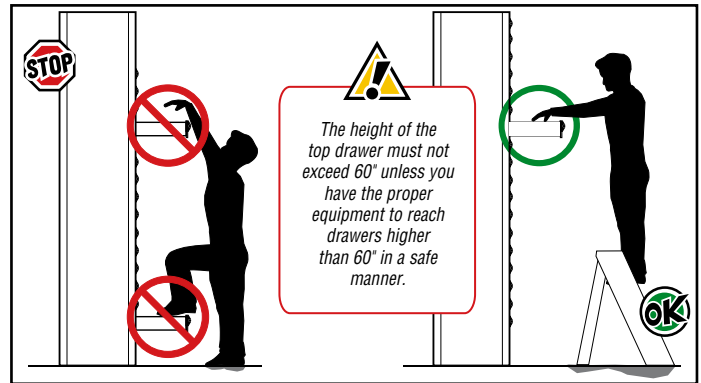

The height of the top drawer must not exceed 60" unless you have the proper equipment to reach drawers higher than 60" in a safe manner.

Heavy-Duty 3-Sided Access Roll-Out Shelf

RF45 Filler

RE90

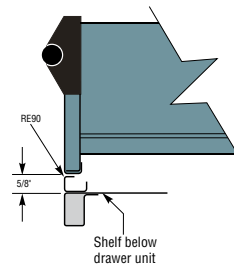

Installs with an adhesive strip under the bank of drawers;

Meets aesthetic requirements of certain work environments (hospitals, offices, etc.);

Offered for Rousseau Spider® and spacesaver shelving only;

For Spacesaver shelving, order RE90-XX02 instead of RE90-XX01.

Product #	W x H
RE90-3601	36" x 5/8"
RE90-4201	42" x 5/8"
RE90-4801	48" x 5/8"



Industrial Shelving Accessories

Locking and Security Mechanisms

SHELVING

Vertical Security Bar

RE80



Locks a bank of drawers in shelving with either a key or a padlock;

Lock or safety hasp for padlock are located at the top of the bar to facilitate access;

Covers a bank of drawers from 18" to 48" high;

Easy hook-on assembly;

Possible to install more than one bar on the same bracket for different users;

Installs on the right side;

36" high bar is compatible with 34" high mounting brackets and 48" high bar is compatible with 46" high mounting brackets;

Offered for Rousseau Spider® shelving. For Spacesaver shelving, order RE81-XXXXA instead of RE80-XXXXA;

Order by specifying the type of lock required. Complete with LP for a safety hasp or with L3 for a standard lock.



Product #	Height
RE80-18_A	18"
RE80-24_A	24"
RE80-30_A	30"
RE80-36_A	36"
RE80-48_A	48"

Lock-out Mechanism

RF85



For both drawers and roll-out shelves;

Locks drawers and roll-out shelves in open position;

Activated manually, only when required;

Compatible with all accessories drawer;

Plastic bins positioned in the back row, may make it more difficult to activate mechanism.

Product #

RF85

Drawer Lock

L3

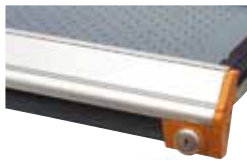

Compatible with all drawer dimensions;

Does not affect usable drawer space;

Easy to retrofit;

Order by adding L3 to drawer or partitioning model number. Ex. : RF32-362406L3;

For replacement parts or to retrofit this mechanism, order RY01-L3.

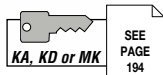

Product #

L3

Integrated Lock-in Mechanism

PATENTED A



Activated by tilting the handle up;

Allows user to open the drawer and the roll-out shelf with one hand only;

Close by simply pushing it;

Stops drawer and roll-out shelf from opening on their own;

Easy to retrofit;

Order by adding A to the drawer or partitioning model number or roll-out shelf. Ex. : RF32-362406A;

For replacement parts or to retrofit this mechanism, order RY08-XXA.

Product #

A

Econo Lock-in Mechanism

B

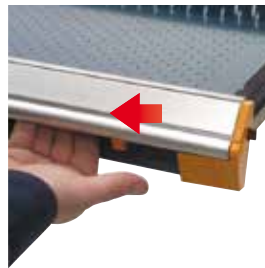

Activated with the right hand by sliding the mechanism with thumb;

Drawer and roll-out shelf closes without having to reactivate the slide mechanism;

Stops drawer and roll-out shelf from opening on their own;

Easy to retrofit;

Order by adding B to the drawer or partitioning model number or roll-out shelf. Ex. : RF32-362406B;

For replacement parts or to retrofit this mechanism, order RY01-B.

Product #

B

Security Panel

RF91

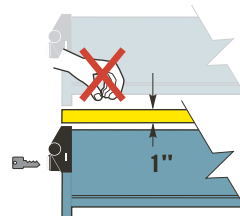

Blocks access between two drawers or two banks of drawers;

Usable space in the bank of drawers is reduced by 1";

Installed between two drawers.

Product #	W x D
RF91-3618	36" x 18"
RF91-3624	36" x 24"
RF91-4218	42" x 18"
RF91-4224	42" x 24"
RF91-4818	48" x 18"
RF91-4824	48" x 24"

Structural Components

Post

SR10 / SH10

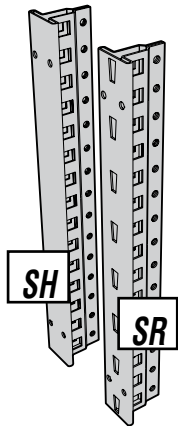

Tubular T-shape; up to 7 fixing zones;
Perforations on sides at every 1" c/c for adjusting shelves;
14 gauge steel;
Choose either :
- The universal SR10 post with the perforated surface to add Mini-Racking or multi-level shelving
- The shelving SH10 post with the smooth finish surface for enhanced appearance.

SR universal post	SH shelving post	Height
SR10-039	SH10-039	39"
SR10-051	SH10-051	51"
SR10-075	SH10-075	75"
SR10-087	SH10-087	87"
SR10-099	SH10-099	99"
SR10-111	SH10-111	111"
SR10-123	SH10-123	123"

Other dimensions available. Contact your customer service representative.

NOTE

The unique shape of the Spider® post is a Rousseau Metal Inc. trademark.

Welded Open Upright

SR11 / SH11

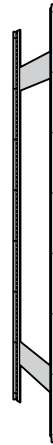

Upright with factory welded side braces;
Fast assembly.

SR universal post	SH shelving post	D x H
SR11-120752	SH11-120752	12" x 75"
SR11-120872	SH11-120872	12" x 87"
SR11-120992	SH11-120992	12" x 99"
SR11-180752	SH11-180752	18" x 75"
SR11-180872	SH11-180872	18" x 87"
SR11-180992	SH11-180992	18" x 99"
SR11-240752	SH11-240752	24" x 75"
SR11-240872	SH11-240872	24" x 87"
SR11-240992	SH11-240992	24" x 99"

Other dimensions available. Contact your customer service representative.

Side Braces

SH34

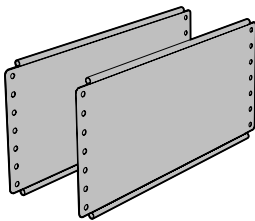

Sold in pairs;
Allow upright assemblies to be fastened in a "ladder-like" manner for easier assembly;
Recommendations :
- 1 pair per upright assembly up to 99" in height
- For upright assemblies over 99" in height, please refer to the S58 technical sheet or contact your customer service representative.

Product #	Depth
SH34-12	12"
SH34-15	15"
SH34-18	18"
SH34-24	24"
SH34-30	30"

Welded Closed Upright

SR12 / SH12



Upright with full-height factory welded parts;
Fast assembly.

SR universal post	SH shelving post	D x H
SR12-12075	SH12-12075	12" x 75"
SR12-12087	SH12-12087	12" x 87"
SR12-12099	SH12-12099	12" x 99"
SR12-18075	SH12-18075	18" x 75"
SR12-18087	SH12-18087	18" x 87"
SR12-18099	SH12-18099	18" x 99"
SR12-24075	SH12-24075	24" x 75"
SR12-24087	SH12-24087	24" x 87"
SR12-24099	SH12-24099	24" x 99"

Other dimensions available. Contact your customer service representative.

Back Brace

SH33

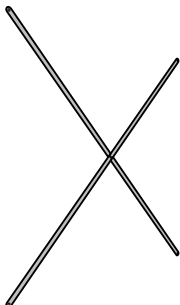

"X" shaped, factory assembled brace;
Easy to install;
Recommendations :
- 1 pair per upright assembly up to 99" in height
- 2 pairs for posts over 99" in height.
Please refer to the S58 technical sheet or contact your customer service representative.

Product #	Width
SH33-36	36"
SH33-42	42"
SH33-48	48"

Corner Gussets

SH35

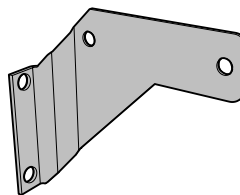

Replace back brace for full access to front and back of shelving unit;
14 gauge steel;
Each set includes 4 gussets. Min. of 3 sets per unit;
Note : Not to be used on units over 99" H or for multi-level shelving.

Product #
SH35

Industrial Shelving Components

SHELVING

Side Panel

SH30

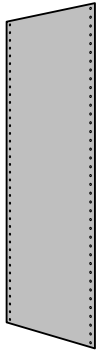

Panel combinations :
 - 75"H posts (39" + 39")
 - 87"H posts (39" + 51")
 - 99"H posts (51" + 51")
 - 111"H posts (39" + 39" + 39")
 - 123"H posts (39" + 39" + 51")

Product #	D x H
SH30-1239	12" x 39"
SH30-1251	12" x 51"
SH30-1539	15" x 39"
SH30-1551	15" x 51"
SH30-1839	18" x 39"
SH30-1851	18" x 51"
SH30-2439	24" x 39"
SH30-2451	24" x 51"

Back Panel

SH31

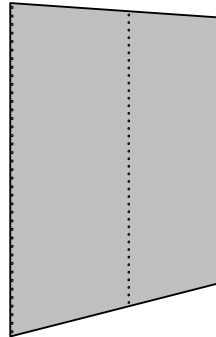

Panel combinations :
 - 75"H posts (39" + 39")
 - 87"H posts (39" + 51")
 - 99"H posts (51" + 51")
 - 111"H posts (39" + 39" + 39")
 - 123"H posts (39" + 39" + 51")

Product #	W x H
SH31-3639	36" x 39"
SH31-3651	36" x 51"
SH31-4239	42" x 39"
SH31-4251	42" x 51"
SH31-4839	48" x 39"
SH31-4851	48" x 51"

Shelf Front or Front Base

SH28

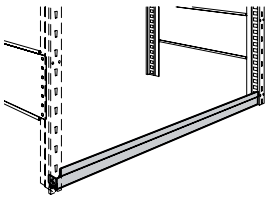

Same component for both applications;
 Fast hook-on installation;
 Note: Front base is always included with closed shelving proposals.

Product #	W x H
SH28-3602	36" x 2"
SH28-4202	42" x 2"
SH28-4802	48" x 2"
SH28-3605	36" x 5"
SH28-4205	42" x 5"
SH28-4805	48" x 5"

Structural Perforated Back Panel

SH39

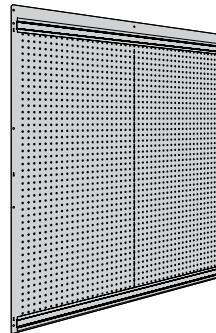

Perforated panel for shelving back;
 Integrated part of the shelving structure;
 Holes at every inch c/c;
 Compatible with WM94, WM95, WM96, WM97, WM98 and WM99 hooks;

Panel combinations :
 - 75" H posts (39" + 39")
 - 87" H posts (39" + 51")
 - 99" H posts (51" + 51")

Note : Used without the SH31 back panels.

Product #	W x H
SH39-3639	36" x 39"
SH39-3651	36" x 51"
SH39-4239	42" x 39"
SH39-4251	42" x 51"
SH39-4839	48" x 39"
SH39-4851	48" x 51"

Installation Accessories

Floor Anchor Plate

SH45

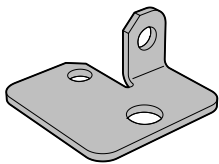

Sold individually;
 Attaches to the post for anchoring shelving sections to the floor. Distributes the load on a larger surface and protects the floor;
 12 gauge galvanized steel.

Product #
SH45

Floor Anchoring Hardware

SH47

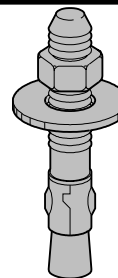

Used for anchoring shelving to the floor;
 Includes 4 cement screws.

Product #
SH47-04

Shim Plate

SH46

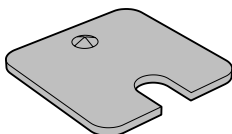

Sold individually;
 Evens out shelving units on uneven surfaces. Slides under SH45 floor anchor plate;
 12 or 16 gauge galvanized steel.

Product #	Thickness
SH46-12	12 gauge (0,100")
SH46-16	16 gauge (0,060")

Wall Spacer

SR47

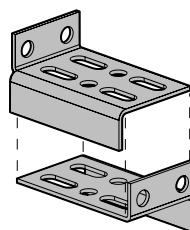

Designed to anchor shelving to the wall;
 Adjusts from 3" to 4";
 Wall anchoring hardware not included (holes are 3/16" in diameter).

Product #
SR47-0304

Industrial Shelving Components

Shelves and Shelf Accessories

Box Shelf



SH20

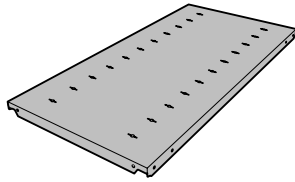

Box-type shelf with front and rear edges roll-formed and welded;
20 gauge steel, 1 1/4" thick;
4 sturdy and compact SH60 clips included;
Perforations for dividers (SH52) at every 3" c/c;
Others dimensions available. Contact your customer service representative.

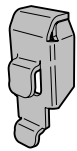

SH60
(4 clips)

Product #	W x D
SH20-3012	30" x 12"
SH20-3015	30" x 15"
SH20-3018	30" x 18"
SH20-3024	30" x 24"
SH20-3612	36" x 12"
SH20-3615	36" x 15"
SH20-3618	36" x 18"
SH20-3624*	36" x 24"
SH20-4212	42" x 12"
SH20-4215	42" x 15"
SH20-4218	42" x 18"
SH20-4224	42" x 24"
SH20-4812	48" x 12"
SH20-4815	48" x 15"

Product #	W x D
SH20-4818	48" x 18"
SH20-4824	48" x 24"

* Also offered with a double fold on the sides.



SHELVING

Shelf Load Capacity

Shelving load capacity tests are based on ANSI MH28.1 Shelving Manufacturer Association (SMA) standards. Capacities incorporate a safety factor and are valid for an equally distributed load. Capacities are indicated in pounds.

NOTE The SH22, SH24 and SHC reinforcements are not factory installed on the SH20 box shelves.

Dimensions W x D	NEW DIMENSION		
	Medium-Duty Capacity Without Reinforcement	Heavy-Duty Capacity Central Reinforcement	Extra Heavy-Duty Capacity Double Reinforcement
36" x 12"	750	—	—
36" x 15"	775	—	—
36" x 18"	800	1000	1100
36" x 24"	625	1050	1100
42" x 12"	650	—	—
42" x 15"	650	—	—
42" x 18"	650	850	1050
42" x 24"	650	875	1050
48" x 12"	550	—	—
48" x 15"	550	—	—
48" x 18"	575	725	1025
48" x 24"	600	750	1050

Center Shelf Reinforcement (Heavy-Duty)



SHC

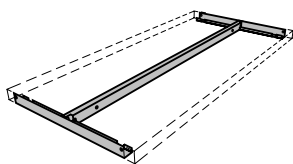

SH24 front shelf reinforcement combined with SH22 side reinforcements.

Product #	W x D
SHC1009	30" x 18"
SHC1010	30" x 24"
SHC1003	36" x 18"
SHC1004	36" x 24"
SHC1007	42" x 18"
SHC1008	42" x 24"
SHC1005	48" x 18"
SHC1006	48" x 24"

Double Shelf Reinforcement (Extra Heavy-Duty)



SHC

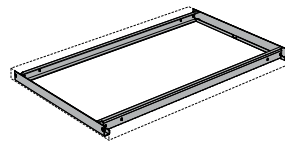

Combination of two front reinforcements (SH24) with two side reinforcements (SH22).

Product #	W x D
SHC2009	30" x 18"
SHC2010	30" x 24"
SHC2003	36" x 18"
SHC2004	36" x 24"
SHC2007	42" x 18"
SHC2008	42" x 24"
SHC2005	48" x 18"
SHC2006	48" x 24"

NOTE Used when the shelves have to support higher loads, concentrated loads or when the visual is important.

Front Shelf Reinforcement



SH24

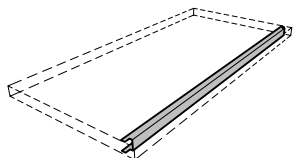

"C" shaped reinforcement. Used when shelves must support heavier loads in front. Note: The reinforcement increases shelf sturdiness, not capacity.

Product #	Width
SH24-30	30"
SH24-36	36"
SH24-42	42"
SH24-48	48"

Side Shelf Reinforcements

SH22

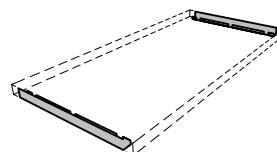

2 "L" shaped reinforcements for attachment on each side of a shelf. Used when shelves must support heavier loads;

The side reinforcements increase the capacity of the 36" x 24" shelf to 800 lb.

Product #	Depth
SH22-18	18"
SH22-24	24"

